

Link Budget Analysis: Error Control & Detection

www.AtlantaRF.com



Atlanta RF

Services, Software & Designs

Presentation Content

Link Budget Analysis: *Error Control & Detection*

1. Cause of Performance Degradation.
2. Sources of Errors.
3. Overview of Error Detection.
4. Error Correction: Basic Principles.
5. Error Control Techniques.
6. ARQ: Automatic Repeat reQuest.
7. Forward Error Correction Codes.
8. Classification of FEC Codes.
9. Applications of Channel Coding.
10. Benefits of FEC.
11. Channel FEC Coding Techniques.
12. Channel Coding Gain.
13. Linear Block Error Correcting Codes.
14. Cyclic Block Error Codes.
15. BCH Error Correcting Codes.
16. Reed-Solomon Error Correcting Codes
17. Interleaving Error Correction Codes.
18. Convolutional Error Correcting Codes.
19. Low Density Parity Check Codes.
20. Concatenated Codes.
21. Turbo Convolutional Codes (TCC).
22. Turbo Product Codes (TPC).
23. Design Trade-offs with FEC.

Refer to background material in Atlanta RF's presentations titled:

1. 'Link Budget – Getting Started' and
2. 'Link Budget: Digital Modulation Part 1' (Overview & M-ASK).
3. 'Link Budget: Digital Modulation Part 2' (M-FSK).
4. 'Link Budget: Digital Modulation Part 3' (M-PSK & QAM).

which can be downloaded from our website: www.AtlantaRF.com.

Atlanta RF

Services, Software & Designs

Data Transmission: Errors are Everywhere

Link Budget Analysis: *Error Control & Detection*

1. Many communication channels suffer from noise, interference or distortion due to hardware imperfections, or physical limitations.
2. Channel coding deals with ***error control techniques***. If the data at the output of a communications system has errors that are too frequent for the desired use, the errors can often be reduced by the use of a number of error control techniques.
3. The ***goal of error control coding*** is to encode digital information in such a way that, even if the channel (or storage medium) introduces errors, the receiver can correct the errors and recover the original transmitted information.

Cause of Performance Degradation

Link Budget Analysis: *Error Control & Detection*

1. Receive Signal loss (E_b term):

- A. The receive signal loses signal strength due to: 1) Distance between Transmitter's antenna and the Receiver's antennas, 2) Absorption of the Tx signal, 3) Scattering of the Tx signal, 4) Reflection of the Tx signal, 5) Refraction of the Tx signal, 6) Antenna pointing errors, etc.

2. Inter-Symbol Interference (N_0 term):

- A. The receive signal is interfered with by near-by transmitted signals, due primarily to frequency-dependent effects (in the channel or by amplifiers).

3. Noise and interference (N_0 term):

- A. InterModulation distortion: IMD.
- B. Interfering signals (co-channel & adjacent channel interference).
- C. Amplifier noise sources (thermal noise, shot noise, flicker noise).
- D. Atmospheric noise and galactic noise sources.

Recall: The energy per bit (E_b) is related to the received signal ($S = P_r$) as:

$$\frac{E_b}{N_0} = \frac{S}{N} + B_w - R_{bits}, dB$$

Example: Receive Signal Loss in 16-QAM

Viewed in QAM's Phase State Constellation Diagram

Receive Signal Loss:

1. Low signal-to-noise ratio (S/N) leads to discrimination errors.
2. Signal loss is due to absorption, scattering, reflection, refraction, pointing, etc.

Bit errors in red

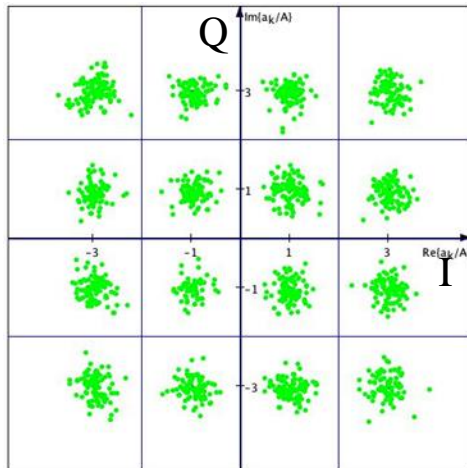

16-QAM with $E_b/N_0 = 11 \text{ dB}$

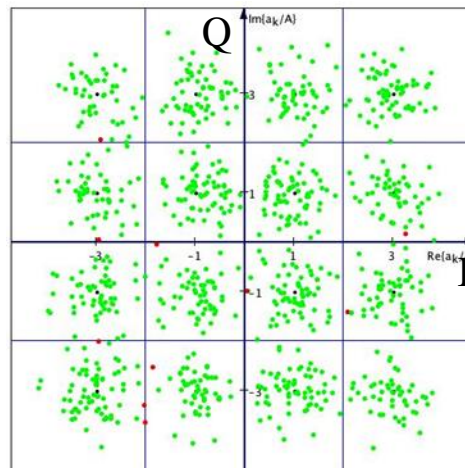

16-QAM with $E_b/N_0 = 6 \text{ dB}$

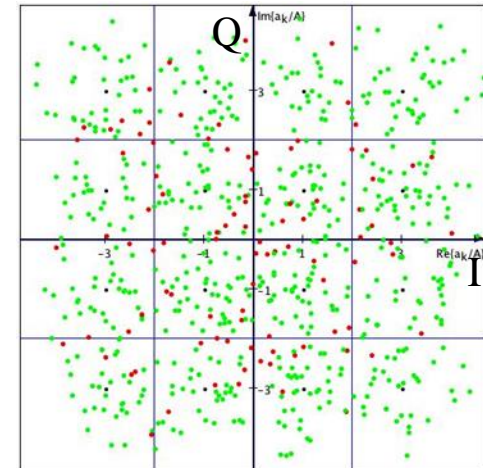

16-QAM with $E_b/N_0 = 2 \text{ dB}$

Recall: The energy per bit (E_b) is related to the received signal ($S = P_r$) as:

$$\frac{E_b}{N_o} = \frac{S}{N} + B_w - R_{bits}, \text{ dB}$$

Atlanta RF

Services, Software & Designs

Sources of Errors

Link Budget Analysis: *Error Control & Detection*

White Noise: $N = kT_s B_w$, watts

1. Also known as thermal or Gaussian noise.
2. Relatively constant.
3. Can be reduced by filters.
4. If white noise gets too strong, can completely disrupt signal.

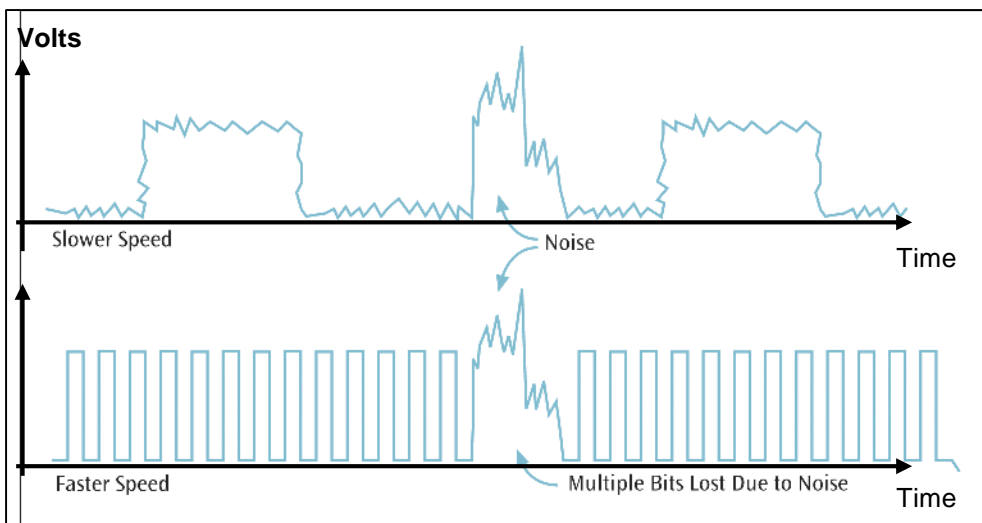
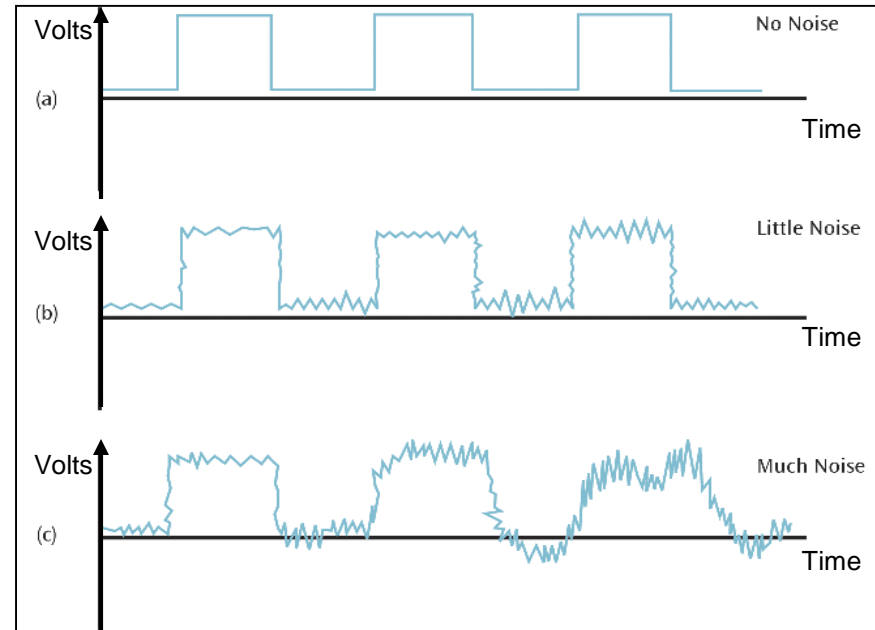

Impulse Noise:

1. One of the most disruptive forms of noise caused by random spikes of power that produce irregular pulses or noise spikes of short duration, which can destroy one or more bits of information.
2. Impulse noise is the primary source of bit-errors in digital data communication: burst errors.
3. Caused by switching, manual interruptions, ignition noise, electrical sparks and lightning.

Atlanta RF

Services, Software & Designs

Sources of Errors

Link Budget Analysis: *Error Control & Detection*

Phase Jitter:

1. The result of small timing irregularities during transmission of digital signals.
2. Occurs when a digital signal is repeated over and over.
3. If serious enough, jitter forces systems to slow down their transmission.
4. Steps can be taken to reduce jitter.

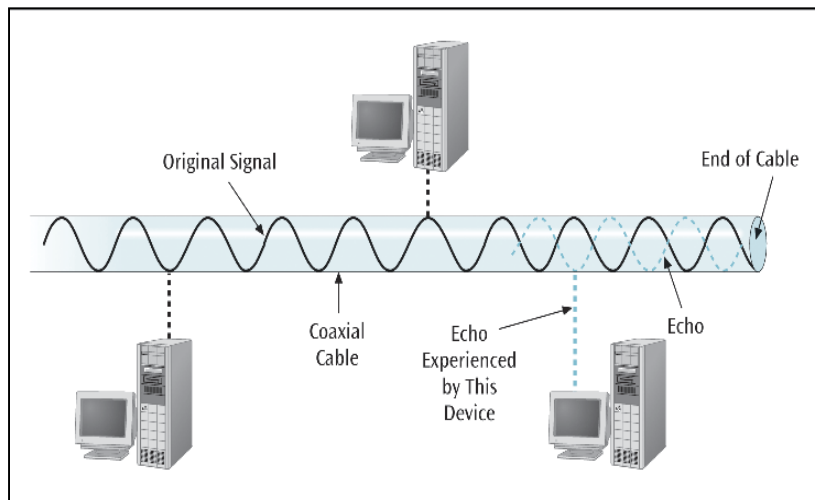
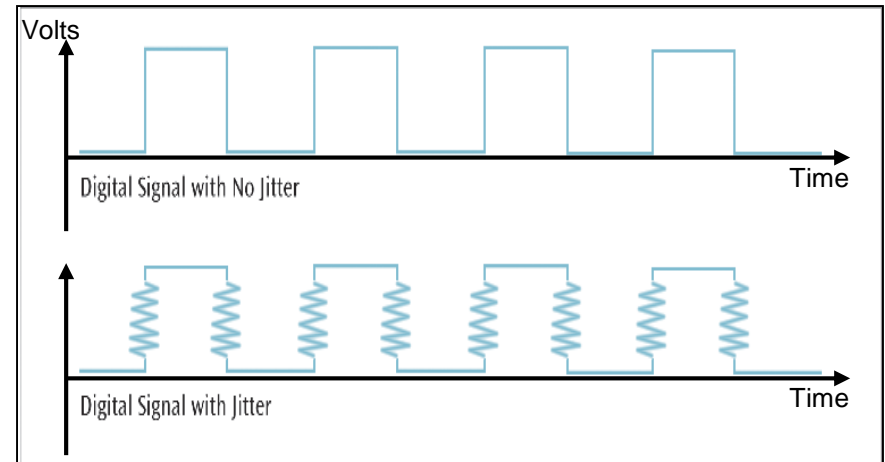

Echo:

1. The reflective feedback of a transmitted signal as the signal moves through a medium.
2. Most often occurs on coaxial cable.
3. If echo bad enough, it could interfere with the original signal.
4. Relatively constant.
5. Can be significantly reduced.

Atlanta RF

Services, Software & Designs

QAM or QPSK Impairments/Errors

When viewed in Phase State Constellation Diagram

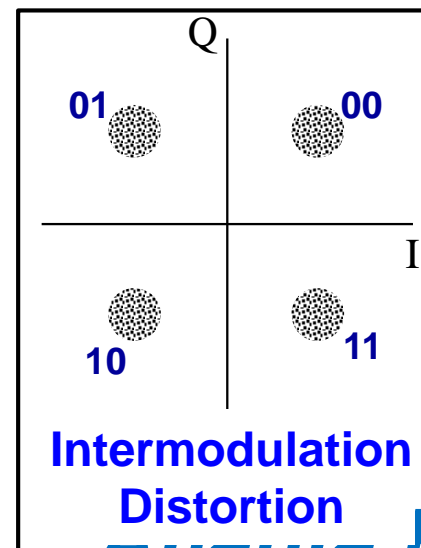
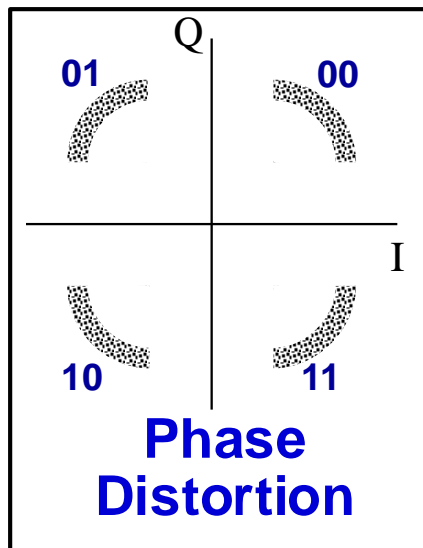
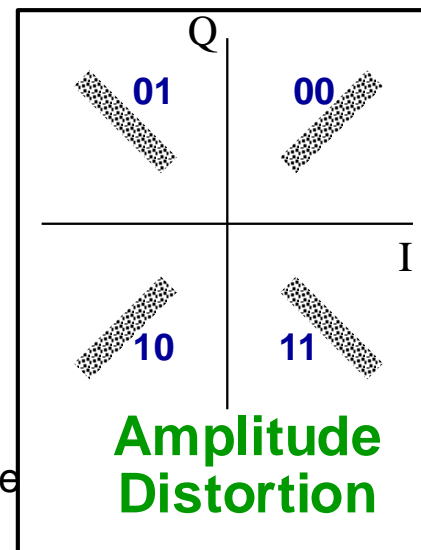
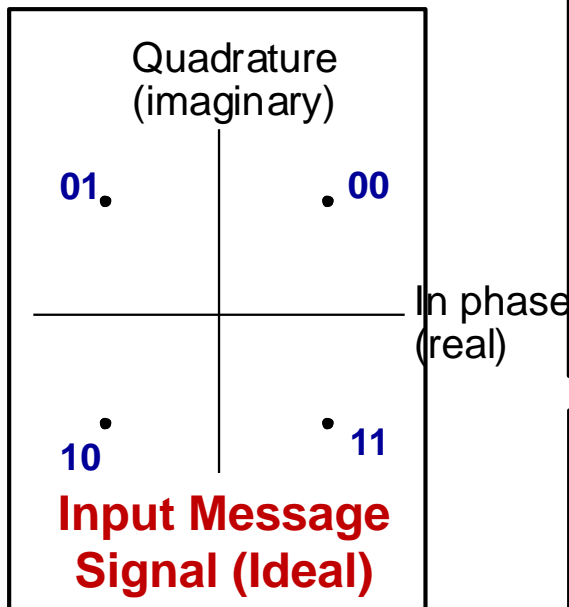
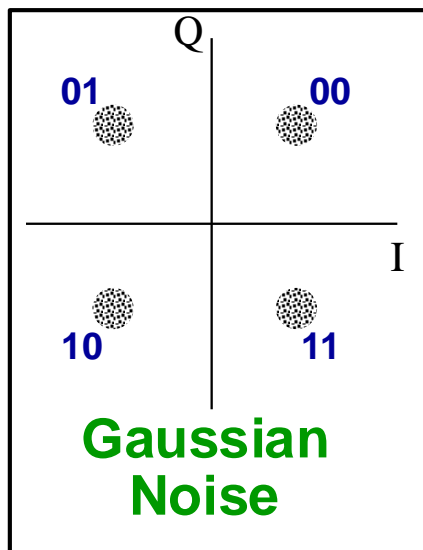

64-QAM Digital Modulation Errors

When viewed in QAM's Phase State Constellation Diagram

Ideal Symbol Point



Random Noise

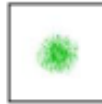

Phase Noise



AM Distortion



PM Distortion

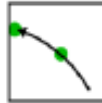

Delay Distortion/ISI



Interference



64 QAM Constellation

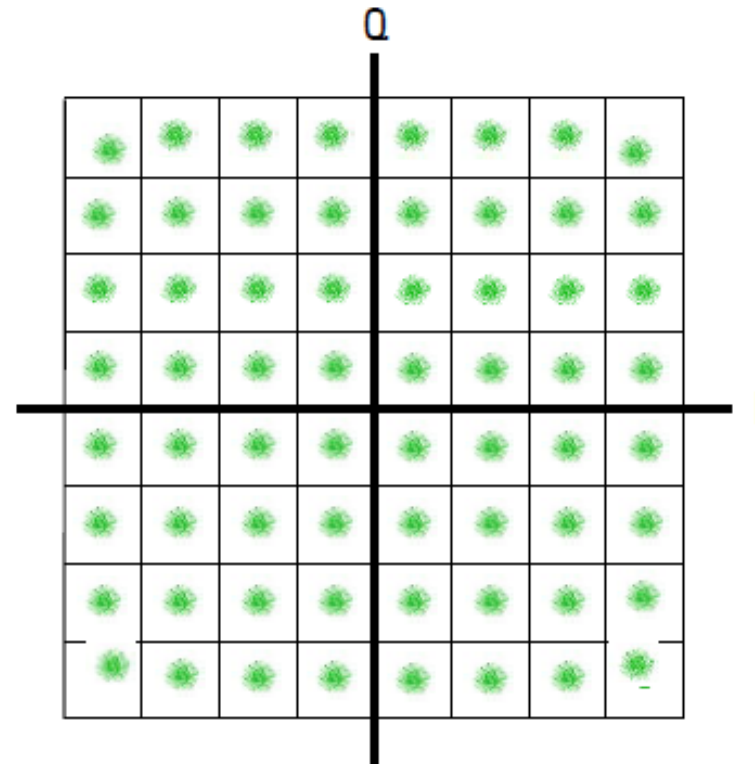

Atlanta RF

Services, Software & Designs

Summary: Sources of Errors and Prevention

Link Budget Analysis: *Error Control & Detection*

Source of error	Cause	Prevention Technique
White noise	Movement of electrons (thermal energy).	Increase signal strength (increase SNR).
Impulse noise	Sudden increases in noise spikes (e.g., lightning, power surges, etc).	Shield or move the wires, special filters and DSP.
Cross-talk	Multiplexer guard bands are too small or wires too close together (coupling).	Increase the guard bands, or move or shield the wires/cable.
Echo	Poor connections (causing signal to be reflected back to the source).	Proper termination of cables; Fix connections, or tune eqpmt.
Attenuation	Gradual decrease in signal over distance (weakening of a transmitted signal).	Use digital repeaters or analog amplifiers to increase signal's RF power level.
Intermodulation noise	Signals from several circuits combine.	Move or shield the wires.
Phase Jitter	Analog signals change phase.	Better circuits; Fewer repeaters

Basic Single-Link Digital Communications System

Link Budget Analysis: *Error Control & Detection*

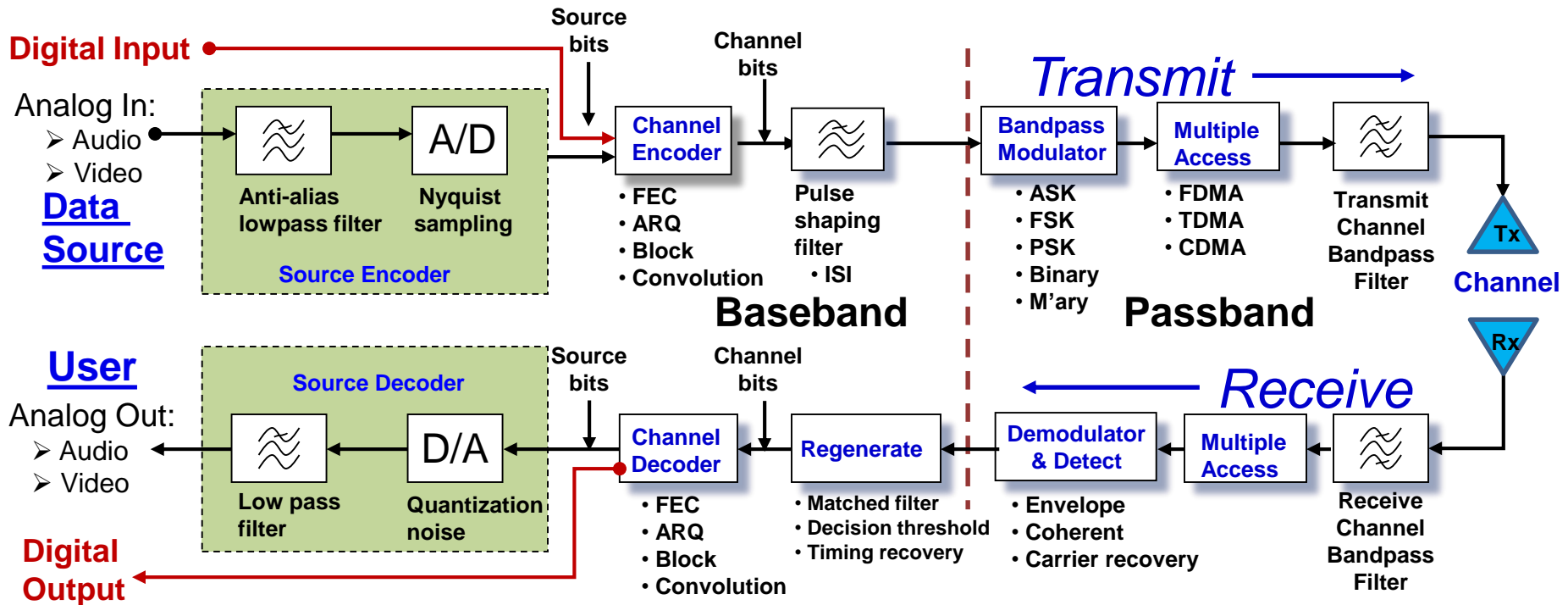

- Source** transmits signals (e.g. speech).
- Source encoder:** Samples, quantizes and compresses the analog signal.
- Channel encoder:** Adds redundancy to enable error detection or correction @ Rx.
- Modulator:** Maps discrete symbols onto analog waveform and moves it into the transmission frequency band.
- Physical channel** represents transmission medium: Multipath propagation, time varying fading, noise, etc.
- Demodulator:** Moves signal back into baseband and performs lowpass filtering, sampling, quantization.
- Channel decoder:** Estimation of information data sequence from code sequence → Error correction.
- Source decoder:** Reconstruction of analog signal.

Atlanta RF

Services, Software & Designs

Overview of Error Detection

Link Budget Analysis: *Error Control & Detection*

1. When high-speed binary data is transmitted over a communication link, **errors** will occur; whether the communication link is twisted-pair wires, coaxial cable, fiber optic cable, magnetic tape or radio/air link.
2. These **errors** produce changes in the data's binary bit pattern caused by interference, fading, distortions, noise, or equipment malfunctions, which cause incorrect data to be received.
3. The number of bit errors that occur for a given number of bits transmitted is referred to as the **bit error rate (BER)**.
4. The process of **error** detection and correction involves **adding extra bits** to the message data characters at the transmitter (redundant bits) to permit **error** detection or correction at the receiver. This process is generally referred to as **channel encoding**.
5. The topic of coding deals with methods of trying to get **transmission channels** to operate at their maximum data transmission capacity.

More.....

Atlanta RF

Services, Software & Designs

Overview of Error Detection....Continued

Link Budget Analysis: *Error Control & Detection*

6. The message data to be transmitted is processed in a way that **creates** the extra bits and adds them to the original message data. At the receiver, these extra bits help identify any **errors** that occur in transmission caused by noise or other channel effects. Think: Matrix multiplication.
7. A key point about channel encoding is that it **takes more time** to transmit the message data because of the extra bits. These extra bits are called **overhead** in that they extend the time of transmission.
8. Channel encoding methods fall into two separate categories, **error detection codes** and **error correction codes**.
9. A number of efficient **error-correction** schemes have been devised to complement **error-detection** methods.
10. The process of detecting and correcting errors at the receiver so that retransmission is not necessary is called **forward error correction** (FEC). There are two basic types of FEC: **block codes** and **convolutional codes**.

Error Correction: Basic Principle

Link Budget Analysis: *Error Control & Detection*

1. All error correcting codes are based on the same basic principle: **redundancy** is added to information in order to correct any errors. In a basic (and practical) form, redundant symbols are appended to information symbols to obtain a coded sequence or **codeword**.
2. Code rate: R_c equals the ratio of length of the uncoded sequence: k to the coded sequence: n , and describes the required expansion of the signal's bandwidth.
3. Basic Idea: **Add extra bits** to a block of information data bits.
 - A. Information data block size: k bits long.
 - B. Error detection redundancy: $r = n - k$ more bits added to block size.
 - 1) The added bits are algebraically related to the buffered bits, based on some **algorithm** for creating those extra redundant bits.
 - C. Results in a frame (data link layer packets are called "frames") of length: n bits.

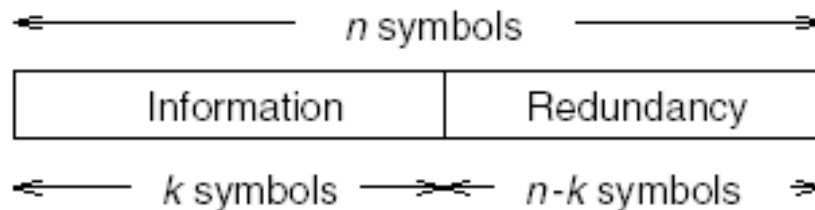

Types of Error Coding in Telecommunications

Link Budget Analysis: *Error Control & Detection*

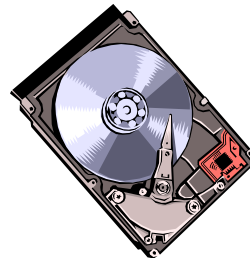
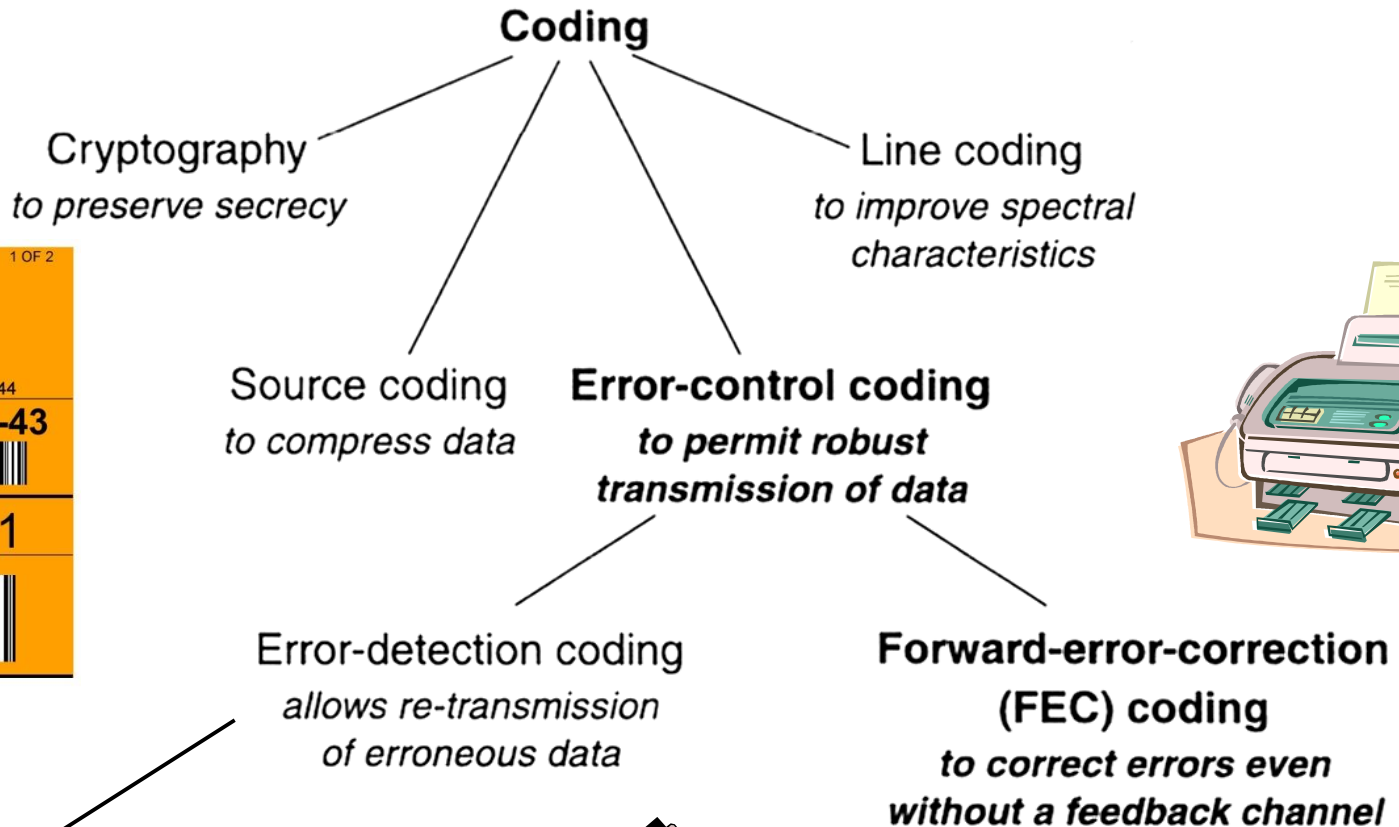

Automatic repeat request (ARQ) coding
to correct errors by using a feedback channel

Error Control Techniques

Channel Coding in Digital Communication Systems

Three approaches can be used to cope with data transmission errors:

1. Automatic Repeat reQuest (**ARQ**): Error detection
 - A. When a receiver circuit detects errors in a block of data, it requests that the block be retransmitted. The receiver sends a feedback to the transmitter: Error is detected (**NACK**: Not-Acknowledgement) in the received packet, then retransmit that data block, or if no errors detected (**ACK**: Acknowledgement), don't resend.
 - B. The transmitter retransmits the previously sent packet if it receives a NACK.
 - C. Uses extra/redundant bits merely for **error detection**.
 - D. Full-duplex (two-way) connection between the Transmitter and the Receiver.
 - E. Result: Constant reliability, but varying data rate throughput due to retransmit.
2. Forward Error Correction (**FEC**): Error detection and correction.
 - A. The transmitter's encoder adds extra/redundant bits to a block of message data bits to form a **codeword**, so the receiver can both detect errors and automatically correct errors incurred during transmission, without retransmission of the data.
 - B. Simplex (one-way) connection between the Transmitter and the Receiver.
 - C. Result: Varying reliability, but constant data rate throughput.
3. Hybrid ARQ (**ARQ+FEC**): Error detection and correction.
 - A. Full-duplex connection required between the Transmitter and the Receiver.
 - B. Uses error detection and correction codes.
4. In general, wire-line communications (more reliable) adopts ARQ scheme, while wireless communications (relatively less reliable) adopts FEC scheme.

Automatic Repeat reQuest (ARQ)

or: Automatic Retransmission Query: ARQ

1. Automatic Repeat Request (ARQ) is a communication protocol where the receiving device detects errors and **requests retransmissions**. As such, ARQ requires a feedback channel between the Receiver (Rx) and the Transmitter (Tx).
2. After each codeword, the Receiver sends back a **positive (ACK)** or **negative (NAK)** acknowledgement to the Transmitter. When the Receiver detects an error in a packet, it automatically requests the Transmitter to resend the packet. This process is repeated until the packet is error free, or the error continues beyond a predetermined number of retransmission events → transmission delays/latency.
3. Three types of Automatic Repeat reQuest: Return an error message to the Tx.
 - A. Stop-and-wait ARQ:**
 - 1) The Receiver waits for an acknowledgement (ACK) of each transmission before transmitting the next data packet/frame.
 - B. Continuous ARQ with pull back:** Go-Back-'N' ARQ.
 - 1) Both the Transmitter and Receiver transmit continuously.
 - 2) In case of NAK (negative Ack), the Transmitter will retransmit the Nth error packet and retransmit all the subsequent data packets/frames.
 - C. Continuous ARQ with selective repeat:** **Selective Repeat ARQ**
 - 1) In case of NAK, the Transmitter will **only** retransmit that Nth error data packet.
 - 2) More complicated operation at the Receiver (re-order data packets, memory).
4. Error correction in ARQ is a little simpler than FEC (just re-transmit), but requires more hardware and requires a feedback channel. ARQ is seldom used in speech communication. Also called: Backward Error Correction.

Atlanta RF

Services, Software & Designs

Types of Forward Error Control Codes

Channel Coding

Major categories of Error Detection and Error Correction Codes:

1. Error **Detection** Codes:

- A. Parity Check codes.
- B. ARC: Arithmetic Redundancy Check codes.
- C. CRC: Cyclic Redundancy Check codes.

2. Block Error **Correction** Codes:

- A. Hamming linear block error correcting codes.
- B. BCH (Bose-Chaudhuri-Hocquenghem) cyclic block codes.
- C. Reed-Solomon cyclic block codes.
- D. Turbo Product Codes (TCP).

3. Convolutional Error **Correction** Code:

- A. Tradition, Viterbi Decoding.
- B. Turbo Convolutional Code (TCC).
- C. Low Density Parity Check Code.

4. Concatenated Error **Correction** Codes: Inner/Outer codes.

- A. Reed-Solomon Error Correction Codes/ Viterbi algorithm.



Classification of FEC Codes

Link Budget Analysis: *Error Control & Detection*

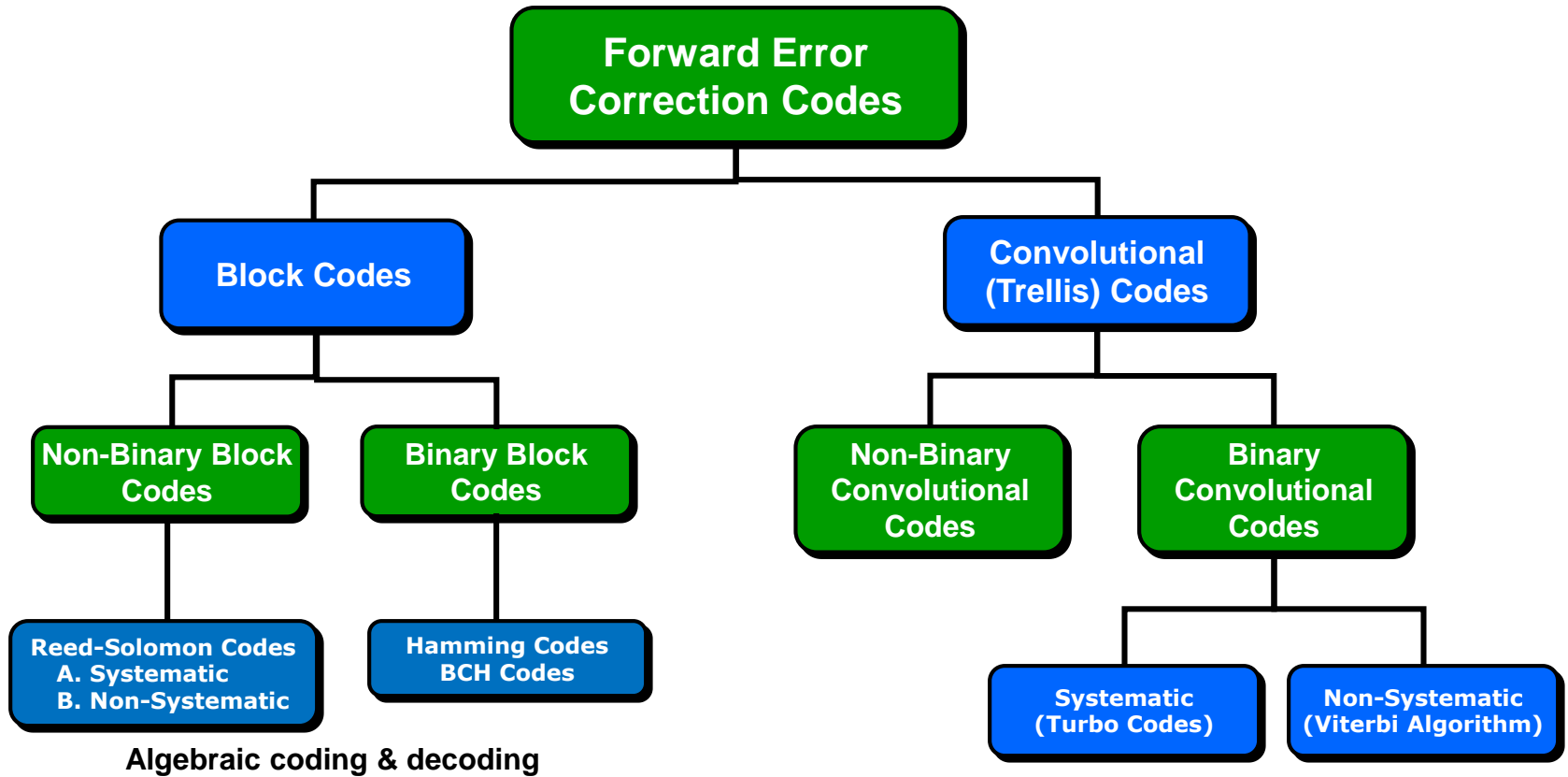

Applications of Channel Coding

Importance of channel coding increased with digital communications

1. First use for deep **space communications** in planetary probes:
 - A. AWGN channel, no bandwidth restrictions, only few receivers (costs negligible).
Early Mariner probes, 1962-1967 (Mars, Venus): No error correction codes used.
 - B. Later Mariner and Viking probes, 1969-1976 (Mars, Venus): Linear block codes, Examples: Viking (Mars), Voyager (Jupiter, Saturn), Galileo (Jupiter), ...
 - C. Convolutional codes with Viterbi decoding: Voyager (1977) forward, Cassini, Mars Exploration Rover, ...
2. Digital **mass storage**:
 - A. Compact Disc (CD), Digital Versatile Disc (DVD), Digital Audio Tapes (DAT), hard disk, ...
3. Digital **wireless communications**:
 - A. GSM, UMTS, Long Term Evolution (LTE), WLAN (Hiperlan, IEEE 802.11), ...
4. Digital **wired communications**:
 - A. Modem transmission (V.32/V.90 use trellis codes), Integrated Services Digital Network (ISDN), Digital Subscriber Line (DSL), ...
5. Digital Audio Broadcasting (**DAB**), Digital Video Broadcasting (**DVB**).
6. Computer buses, Memory subsystems, Digital broadcasting.



Coding can only be used in digital communication systems.

Atlanta RF

Services, Software & Designs

Benefits of Forward Error Correction

For a Digital Communication System

1. Advances in FEC can offer an **improvement** of 3dB to 5dB in system performance. Especially dramatic improvement against fading channels.
2. Designers can choose between levels of improved data reliability, reduced systems costs or increases in range. An extra 3 dB of Coding Gain can:
 - A. Reduce the required frequency **bandwidth** by 50% (OPEX), or
 - B. Increase **data throughput** by a factor of 2 (OPEX), or
 - C. Reduce **antenna size** by 30% (CAPEX), or
 - D. Reduced ground G/T (CAPEX), or
 - E. Increase **range/distance** by 40% or reduce the transmitter's **RF power** by a factor of 2 (CAPEX), or
 - F. Provides more **link margin** during off-axis operation (Higher Service Level).
 - G. Access by more users to the **same radio frequency** in a multi-access communication system can be ensured by the use of error control technique.
 - H. Jamming margin in a **spread spectrum** communication system can be effectively increased by using suitable error control technique.
3. The **Cost** ?
 - A. Increased bit overhead (line rate), time delay, and processing complexity.

OPEX: Operational Expenditure (\$\$)
CAPEX: Capital Expenditure (\$\$)

Channel FEC Coding Techniques

Link Budget Analysis: *Error Control & Detection*

1. Forward Error Correction (FEC) coding techniques are classified as either **block codes** or **convolutional codes**. The classification depends on the presence or absence of memory.
2. A **block code** has **no memory**, since it collects and therefore isolates k -bits in a buffer prior to processing:
 - A. There is no retention within the encoding system of information related to the previous samples points → **memoryless**.
 - B. Each output codeword of an **(n,k) block code** depends only on the current buffer.
3. A **convolutional coder** may process one or more samples during an encoding cycle:
 - A. The number of sample points collected prior to processing is far less than required for a block code. The delay through the encoder is therefore far less.
 - B. The encoder acts on the serial bit stream as it enters the transmitter.
 - C. Each bit in the output stream is not only dependent on the current bit, but also on those processed previously. This implies a form of **memory**.
 - D. Its performance is less sensitive to Signal-to-Noise Ratio variations than that of block codes. In situations of limited power, where Signal-to-Noise Ratios would be a concern, the preferred method for achieving FEC is: Convolutional codes.

Channel Coding Gain

Link Budget Analysis: *Error Control & Detection*

The coding gain produced by an error correcting code is defined as the **reduction** of E_b/N_0 (in dB) that is needed to obtain the same error rate. Channel coding allows the use of lower signal power (smaller E_b/N_0) to achieve the same error rate (BER) we would have had without using correction bits, since errors can be corrected.

- A. Example: For a BER of 10^{-6} , $(E_b/N_0)_c = 11$ dB is needed for the $\frac{1}{2}$ rate code, as compared to $(E_b/N_0)_u = 13.77$ dB without the coding. This is a coding gain: $G = 2.77$ dB.
- B. Probability of an error in decoded data block is lower with FEC than without it.
- C. Equivalent to an increase in Signal-to-Noise Ratio (SNR).
- D. Improved performance for a given SNR, or same BER performance for lower SNR.

$$G [\text{dB}] = \left(\frac{E_b}{N_0} \right)_u [\text{dB}] - \left(\frac{E_b}{N_0} \right)_c [\text{dB}]$$

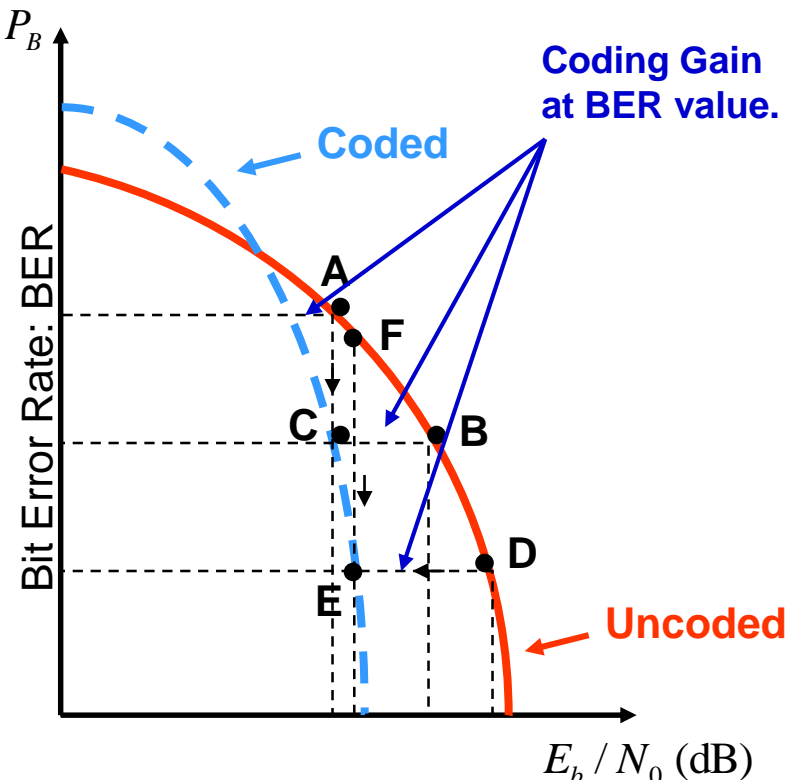

Linear Block Error Correction Codes: Overview

Link Budget Analysis: *Error Control & Detection*

1. Block Codes are generally the simplest types of error correction codes.
2. Examples of popular Block error correction codes:
 - A. Repetition Codes.
 - B. Hamming Codes.
 - C. Reed-Solomon Codes.
 - D. BCH Codes: Bose-Chaudhuri-Hocquenghem Codes.
 - E. Golay Codes.
 - F. Turbo Product Codes.
 - G. Low Density Parity Check (LDPC) Codes.
3. One of the ***famous classes*** of block codes is the Hamming (7, 4) Code. This code is capable of correcting 1 bit of error in each block of 4 bits of data.
4. Essentially, all iteratively-decoded codes are block error correction codes.
5. Key property: The sum of any two codewords is ***also*** a codeword, which is a necessary and sufficient for the code to be linear.

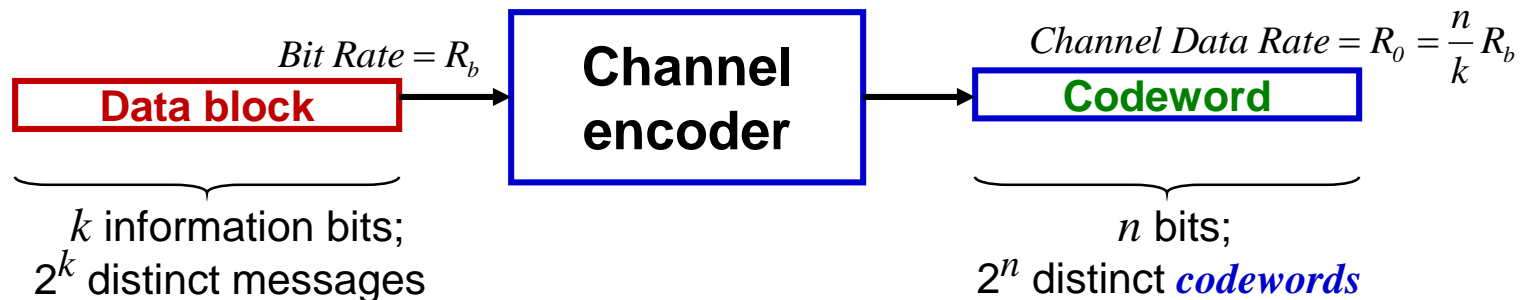

Linear Block Error Correction Codes

Principle of Operation

1. In block codes, the input data stream is partitioned/divided into small blocks of information bits: k (*dataword*). Several redundancy bits: r (called 'parity bits' or 'check bits') are added to each *dataword* block, which computes a unique larger block of total length: $n = k + r$ coded bits

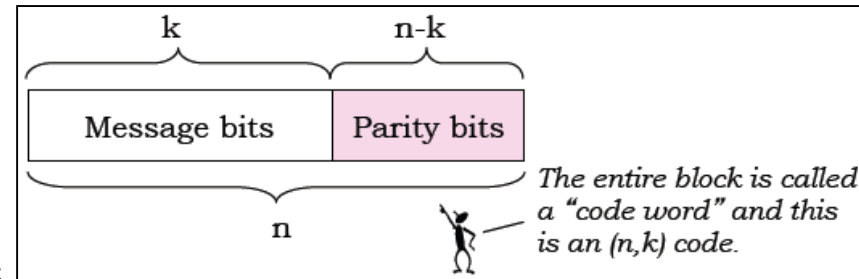

- ($n > k$), called a '*codeword*' (a code vector) via a *linear transformation*, which are modulated and transmitted over a transmission channel \rightarrow *memoryless*. The reverse procedure is done at the receiver, where the Decoder looks for a *codeword* closest to the received vector (= code vector + error vector).
2. The parity bits: r carry no extra information (they are redundant) but help to detect and/or correct **raw bit** errors at the receiver.
 3. The error correcting code is called a: (n, k) *linear block code*.
 4. With a (n, k) code, there are 2^k valid *codewords* out of a possible 2^n *codewords*.
 5. The code rate: R_c defines the ratio of the number of bits in the original data block: k to the transmitted data block: n , or Code Rate = $R_c = k/n$.
 6. Example: A simple repetition code, repeating each symbol 3 times (input k : 'x', output n : 'xxx') has a code rate: $R_c = k/n = 1/3$.

Hamming Error Correction Codes

Link Budget Analysis: *Error Control & Detection*



Richard W. Hamming
(1915- 1998)

1. Hamming* codes are a subclass of linear block codes and belong to the category of **perfect codes** ('perfect' for 1-bit error correction).
2. Hamming codes are expressed as a function of a single integer: m .

$$\text{Code length : } m \geq 2 \quad n = 2^m - 1$$

$$\text{Number of information bits : } k = 2^m - m - 1$$

$$\text{Number of parity bits : } n - k = m$$

$$\text{Error correction capability : } t = 1$$

3. Popular Hamming code: (4,7) with 7-bit codewords ($k = 4$ information bits & $m = 3$ redundant bits) which **detects** all one- and two-bit errors and **corrects** all 1-bit errors ($n = 7$). Code efficiency: $R_c = 4/7 = 57\%$.

* Hamming, Richard W. , "Error detecting and error correcting codes", *Bell System Technical Journal* , Volume 29, Number 2, April 1950, pages 147–160.

Example: Hamming Code impact on BER

For QPSK & 8PSK Modulation

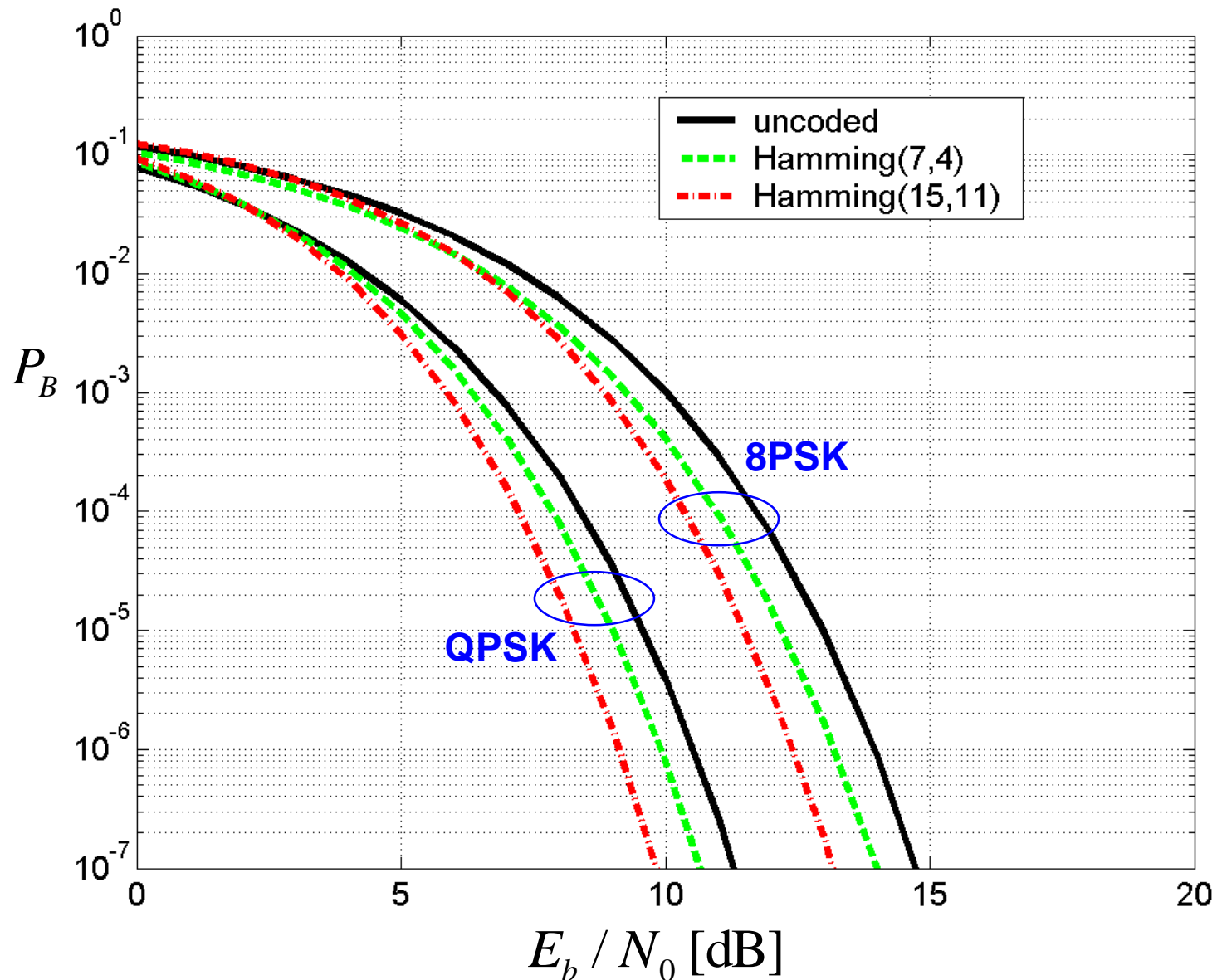

Cyclic Block Error Codes: Overview

Link Budget Analysis: *Error Control & Detection*

1. Cyclic codes are an important **subclass** of linear block codes.
 - A. BCH and Reed-Solomon codes are cyclic codes.
 - B. First published by Eugene Prange* in 1957.
2. A linear (n,k) code is called a **cyclic block code** if *all cyclic shifts of a codeword are also codewords*.
3. Cyclic block codes are of interest and importance in error detection and error correction because:
 - A. They possess rich inherent algebraic structure that can be utilized in a variety of practical methods for decoding them.
 - B. They have extremely concise specifications.
 - C. Encoding and computation can be easily performed by using simple **shift registers** with feedback connections (or linear sequential circuits). Hence, relatively long block codes can be implemented with reasonable complexity.

* E. Prange , *Cyclic error-correcting codes in two symbols*, Air Force Cambridge Research Center, Cambridge, MA (1957), pages 57-103.

Cyclic Redundancy Check (CRC) Codes

Overview

1. Cyclic Redundancy Check, also known as a polynomial code, is a mathematical technique for **detecting errors** in digital data, but **not** for making corrections when errors are detected. It is used primarily in synchronous data transmission. Invented by *W. Wesley Peterson*, and published* in 1961.
2. In the CRC method, a certain number of check bits, often called a checksum, are appended to the message being transmitted. The receiver can determine whether or not the check bits agree with the data, to ascertain with a certain degree of probability whether or not an error occurred in transmission. If an error occurred, the receiver sends a “negative acknowledgement” (NAK) back to the sender, requesting that the message be **retransmitted**: ARQ.
3. When this polynomial code method is employed, the sender and receiver must agree upon a **generator polynomial: $G(x)$** , in advance.
4. CRC codes have considerable *burst-error detection capability* and effectively **catches 99.9%** or more of transmission errors.

*Peterson, W. W. and Brown, D.T. “Cyclic Codes for Error Detection.”
Proceedings of the IRE, January 1961, pages 228–235.

Cyclic Redundancy Check (CRC)

Principle of Operation

1. CRC error **detection** method treats packet of data to be transmitted as a large polynomial.
2. Transmitter processing:
 - A. Using polynomial arithmetic, divides polynomial by a given 'generating' polynomial.
 - B. Quotient is discarded.
 - C. Remainder error control bits: r are "attached" to the end of the data message.
 - D. Data message (with the remainder) is transmitted to the receiver.
3. Receiver processing:
 - A. Divides the data message and remainder by the same 'generating' polynomial.
 - B. If a remainder 'not equal to zero' results → Error during transmission.
 - C. If a remainder of zero results → No error during transmission.
4. Example: A 16-bit checksum (CRC-16) catches all single and double errors, all errors with an odd number of bits, all burst errors of length 16 or less, 99.997% of 17-bit error bursts, and 99.998% of 18-bit and longer bursts.

CRC Code Name	r	Generator Polynomial: $G(x)$	Application
CRC-4	4	$x^4 + x + 1$	ITU-G.704
CRC-8	8	$x^8 + x^2 + x + 1$	ATM header
CRC-10	10	$x^{10} + x^9 + x^5 + x^4 + x + 1$	ATM AAL
CRC-12	12	$x^{12} + x^{11} + x^3 + x^2 + x + 1$	Telecom
CRC-16	16	$x^{16} + x^{15} + x^2 + 1$	Phones
CRC-CCITT	16	$x^{16} + x^{12} + x^5 + 1$	Bluetooth
CRC-32	32	$x^{32} + x^{26} + x^{23} + x^{22} + x^{16} + x^{12} + x^{11} + x^{10} + x^8 + x^7 + x^5 + x^4 + x^2 + x + 1$	LANs

BCH Error Correcting Codes: Overview

Link Budget Analysis: *Error Control & Detection*

1. Bose, Ray-Chaudhuri, Hocquenghem* (BCH) error *correcting* codes
 - A. Multiple error correcting ability.
 - B. Ease of encoding and decoding.
2. Most powerful cyclic code:
 - A. For any positive integer m and $t < 2^{(m-1)}$, there exists a t -error correcting (n, k) code with $n = 2^m - 1$ and $n - k \leq m t$.
3. Industry standards:
 - A. (511, 493) BCH code in ITU-T. Rec. H.261 “video codec for audiovisual service at kbit/s” a video coding a standard used for **video conferencing** and **video phone**.
 - B. (40, 32) BCH code in ATM (Asynchronous Transfer Mode).

* Bose, R. C. ; Ray-Chaudhuri, D. K., (March 1960), "On A Class of Error Correcting Binary Group Codes", *Information and Control*, Volume 3 (1): pages 68–79.

Bit error rates for BCH codes (Length $n = 255$)

Modulation: Binary Phase Shift Keying (BPSK)

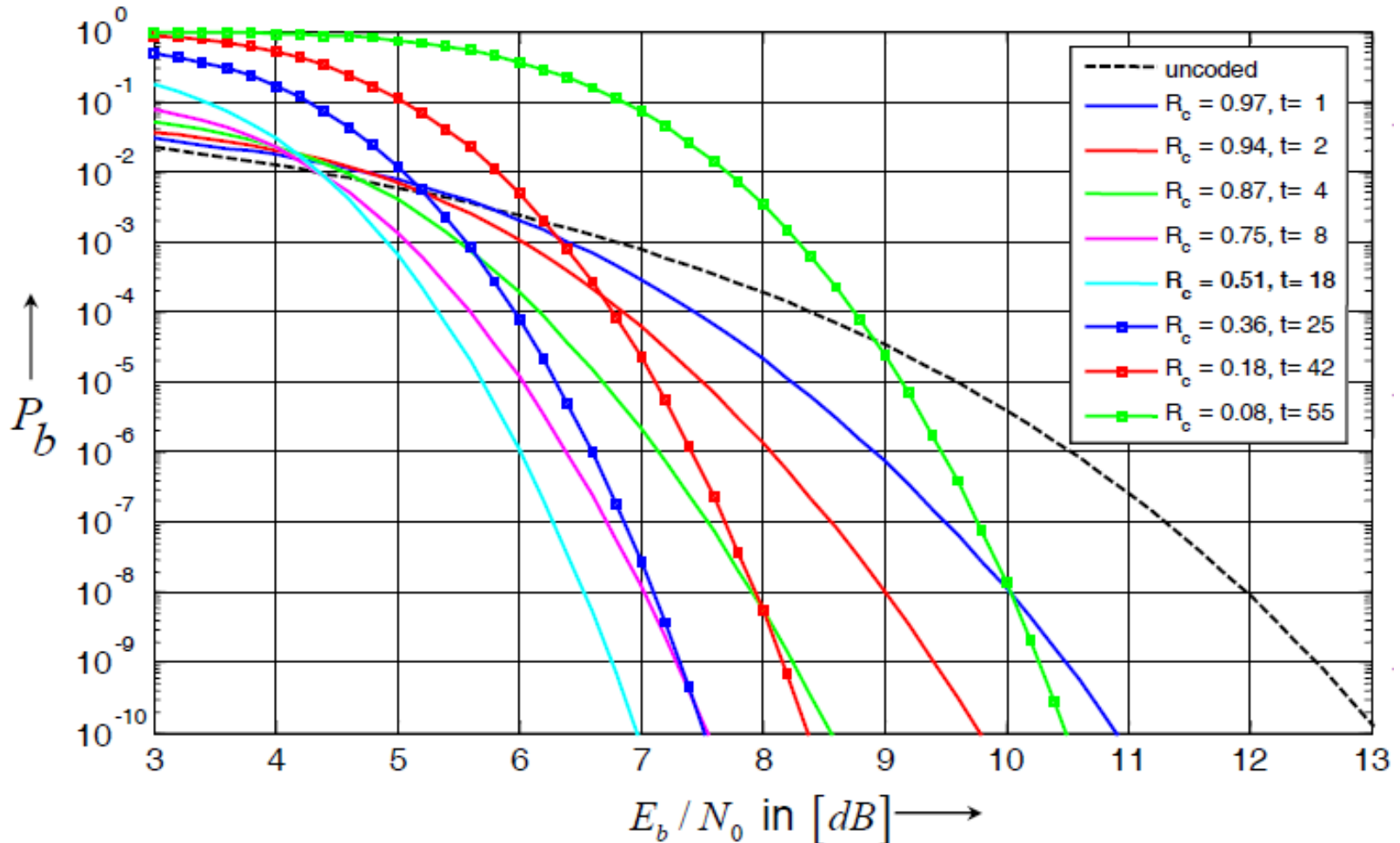

At first, the BER decreases with decreasing Code Rate: R_c . For $t > 25$, the performance worsens \rightarrow BCH codes are asymptotically bad.

Atlanta RF

Bit error rates for BCH codes (Code rate: $R_c = 1/2$)

Modulation: Binary Phase Shift Keying (BPSK)

Comparison of BCH codes with different block length n , but constant rate $R_c \sim 1/2$.

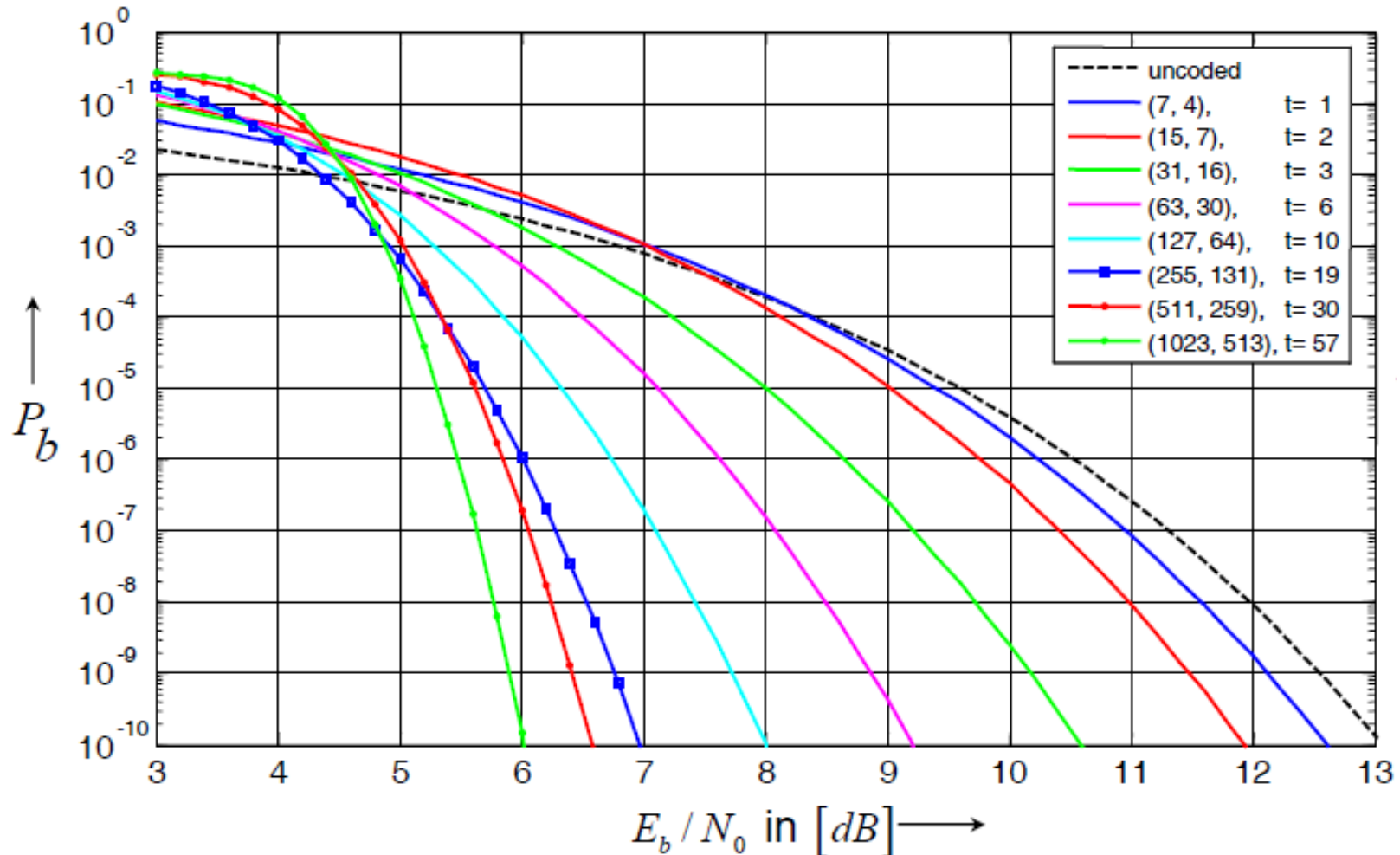

For constant R_c , the BER performance increases significantly with block length n .

Atlanta RF

Services, Software & Designs

Bit error rates for BCH codes (Code rate: $R_c = 1/4$)

Modulation: Binary Phase Shift Keying (BPSK)

Comparison of BCH codes with different block length n , but constant rate $R_c \sim 1/4$.

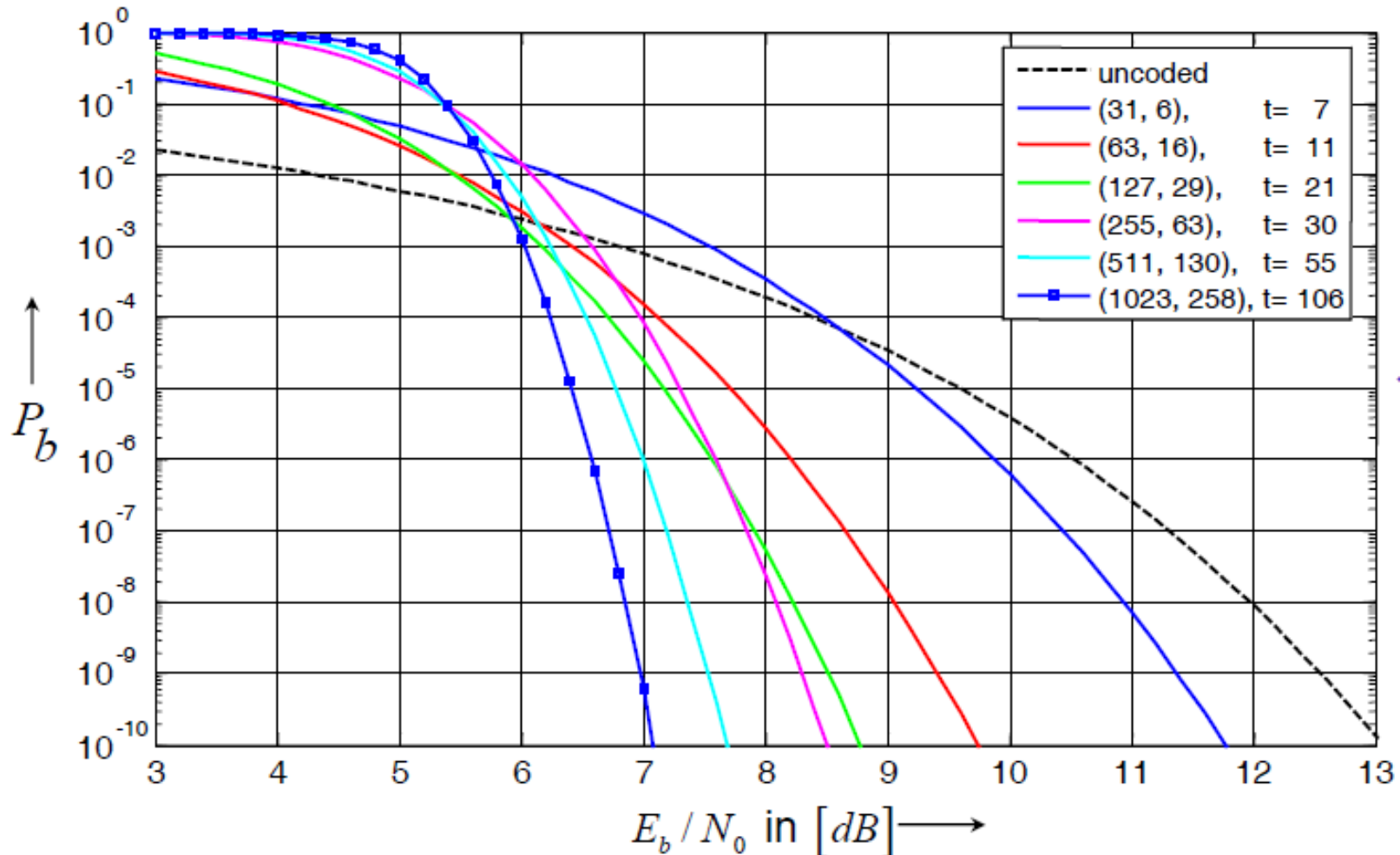

For constant R_c , the BER performance increases significantly with block length n .

Atlanta RF

Services, Software & Designs

Bit error rates for BCH codes (Code rate: $R_c = 3/4$)

Modulation: Binary Phase Shift Keying (BPSK)

Comparison of BCH codes with different block length n , but constant rate $R_c \sim 3/4$.

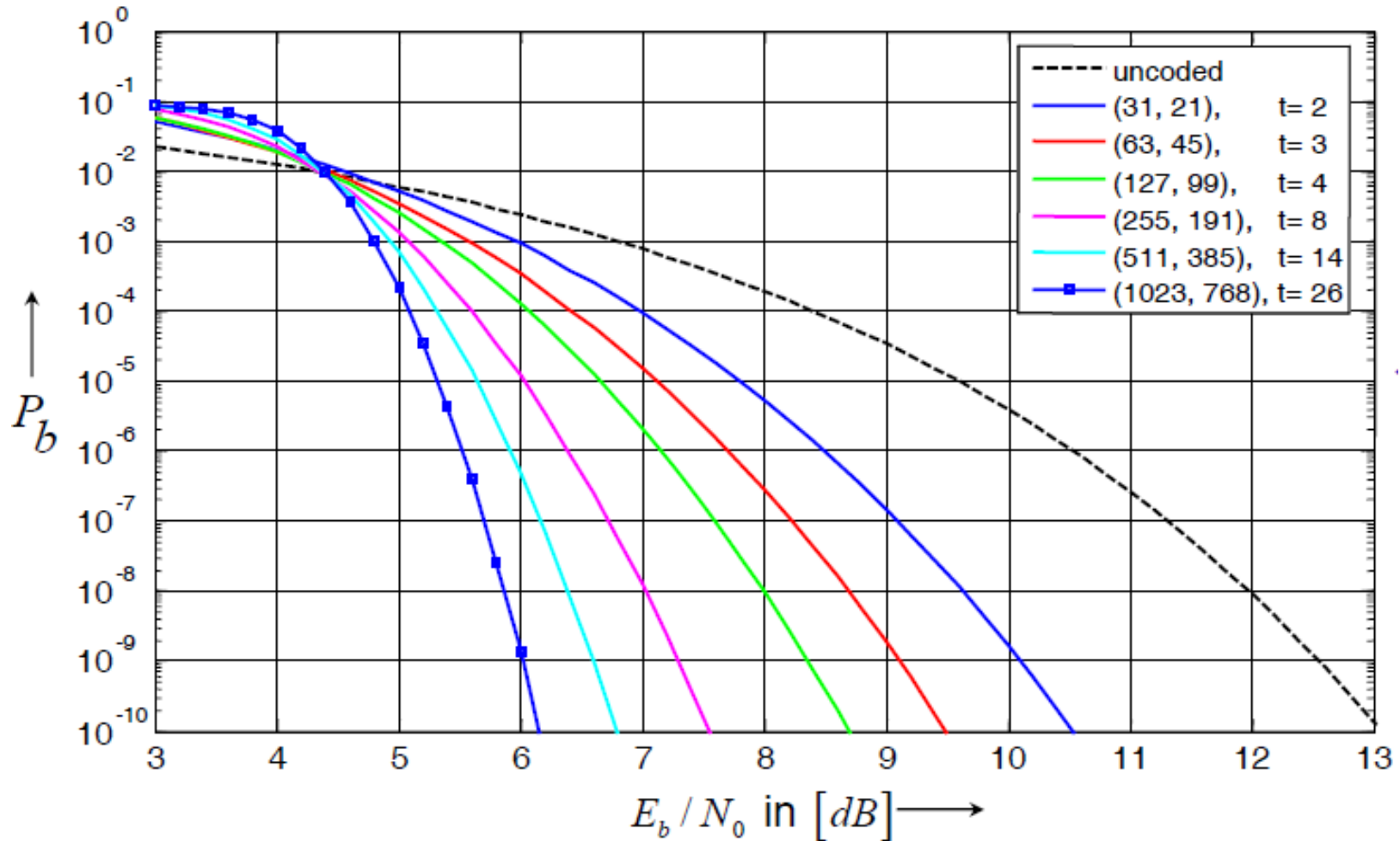

For constant R_c , the BER performance increases significantly with block length n .

Atlanta RF

Services, Software & Designs

Reed-Solomon Error Correcting Codes: Overview

Link Budget Analysis: *Error Control & Detection*

1. Reed Solomon (R-S) codes form an important sub-class of the family of Bose-Chaudhuri-Hocquenghem (BCH) block-based codes and are very powerful linear non-binary block codes capable of correcting multiple random errors, as well as '**burst-error**' correction; that is, they are effective for channels that have memory.
2. In 1960, Irving Reed and Gus Solomon published a paper* that described a new class of error-correcting codes, now called: **Reed-Solomon (R-S) codes**.
3. These R-S codes have great power and utility, and are used to correct errors in many digital communication systems including:
 - A. Storage devices: Magnetic tape, Compact Disk, DVD, barcodes, etc...
 - B. Wireless/mobile communications: Cellular telephones, microwave links, etc.
 - C. Satellite communications.
 - D. Digital television/Digital Video Broadcast (DVB).
 - E. High-speed modems such as ADSL, xDSL, etc.
4. Reed-Solomon codes achieve the **largest possible code minimum distance for any linear code** with the same encoder input and output block lengths.
5. RS coding is eight times more faster than convolutional coding.

* Reed, I. S. and Solomon, G., "Polynomial Codes Over Certain Finite Fields", *SIAM Journal of Applied Math.*, Volume 8, 1960, pages 300-304.

Reed-Solomon Error Correcting Codes

Principle of Operation

1. A Reed-Solomon codeword consists of a block of data “**symbols**”, with parity symbols appended.
2. An (n, k) Reed-Solomon error correction code has parameters:
 - A. Symbol length: m bits per symbol.
 - B. Block length: $n = 2^m - 1$ symbols,
 $= m(2^m - 1)$ bits.
 - C. Message data length: $k = 2^m - 1 - 2t$, symbols.
 - D. Size of parity check code: $n - k = 2t$ symbols = $m(2t)$ bits.
 - E. Minimum distance: $d_{\min} = 2t + 1$ symbols.
3. Input bits are first packed into small blocks of k symbols, which are then packed in super blocks with n symbols by adding redundant bits.
4. RS decoder can correct t symbols in the codeword according to:
$$2t = n - k.$$
5. Example: RS(204,188, T=8) has 16 redundant bits and the possibility to correct 8 bits:
$$2t = n - k = 204 - 188 = 16 \text{ redundant bits and } t = 8 \text{ corrected bits.}$$
6. One bit is used for synchronization and 187 bits contain information.
7. Transmission of information is decreased by the code rate: $R_c = k/n$.

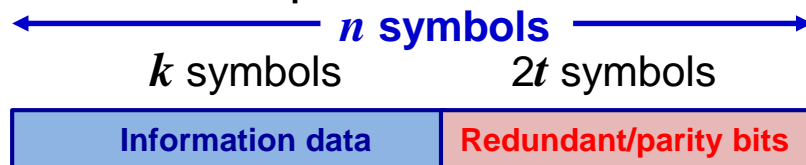

Bite Error Rate for Reed Solomon Codes

Modulation: Binary Phase Shift Keying (BPSK)

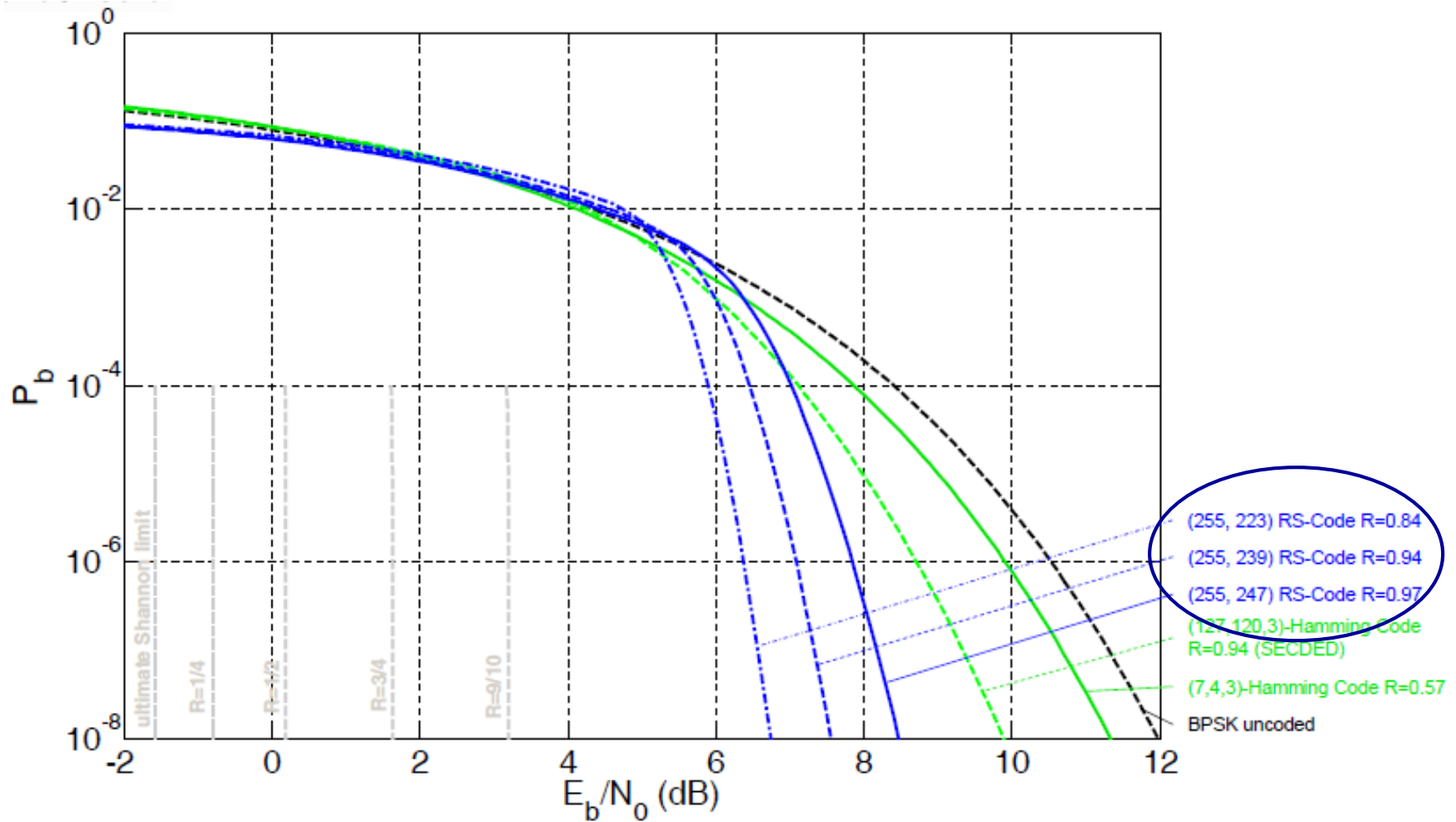

Parameters for a few Reed-Solomon Codes

Link Budget Analysis: *Error Control & Detection*

A large number of R-S codes are available with different code rates:

Code No.	Code Name	Block Length (n)	No.of information symbols in a code word (k)	Error correcting power (t)	Code Rate (R)	Field of Definition
1	(31, 27) R – S	31	27	2	0.871	GF(25)
2	(31, 21) R – S	31	21	5	0.677	
3	(31, 15) R – S	31	15	8	0.484	
4	(31, 11) R – S	31	11	10	0.355	
5	(63, 55) R – S	63	55	4	0.873	GF(26)
6	(63, 47) R – S	63	47	8	0.746	
7	(63, 39) R – S	63	39	12	0.619	
8	(63, 31) R – S	63	31	16	0.492	
9	(63, 23) R – S	63	23	20	0.365	
10	(63, 15) R – S	63	15	24	0.238	
11	(255, 233) R – S	255	233	11	0.913	GF(28)
12	(255, 225) R – S	255	225	15	0.882	
13	(255, 205) R – S	255	205	25	0.804	
14	(255, 191) R – S	255	191	32	0.749	
15	(255, 183) R – S	255	183	36	0.718	
16	(255, 175) R – S	255	175	40	0.686	
17	(255, 165) R – S	255	165	45	0.647	
18	(255, 135) R – S	255	135	60	0.529	

Interleaving

Link Budget Analysis: *Error Control & Detection*

1. Convolutional error correction codes are suitable for memoryless channels with randomly distributed and statistically independent error events.
2. Some channels exhibit **burst-error** characteristics, like: errors in multipath fading channels in wireless communications, errors due to switching noise,
3. “Interleaving” makes the channel look like as a **memoryless** channel.
4. Interleaving is done by spreading the coded symbols in time (interleaving) before transmission. A burst error that may occur is spread out over a number of blocks, making error correction possible at the receiver’s decoder.
5. The reverse is done at the receiver by deinterleaving the received sequence.
6. “Interleaving” makes bursty errors look like random independent errors. Hence, convolutional and turbo product codes can still be used.
7. Interleaving is neither error-correcting or error-detecting; it is an error **avoidance** technique. There is **no coding gain** associated with interleaving.
8. The tradeoff in choosing the size of the interleaver is between time scale of bit dispersal and tolerable delay times/latency in transmission.
9. Types of interleaving: Block interleaving; Convolutional or cross interleaving

Convolutional Error Correcting Codes: Overview

Link Budget Analysis: *Error Control & Detection*

1. Convolutional error correcting codes are applied in applications that require good performance with low implementation cost.
 - A. Easy implementation using a linear finite-state shift registers.
2. Convolutional codes offer an approach to *error control coding* substantially different from that of block codes.
3. They encode/operate on serial information *code streams* rather than on information blocks, as do Block error correcting codes.
4. Convolution codes have *memory* that utilizes previous bits to encode or decode following bits (Block codes are *memoryless*).
5. Its performance is less sensitive to Signal-to-Noise Ratio variations than that of Block codes. In situations of limited power where SNR would be a concern, the *preferred method* for achieving FEC is based on convolutional codes.

Convolution is a mathematical operation on two functions: f and g , producing a third function that is typically viewed as a modified version of one of the original functions, giving the area overlap between the two functions as a function of the amount that one of the original functions is translated. . . . definition from Wikipedia.com

Atlanta RF

Services, Software & Designs

Convolutional Error Correcting Codes: Definition

Link Budget Analysis: *Error Control & Detection*

1. Convolutional codes are generated using **linear finite-state shift registers** to apply a polynomial to a stream of data. Convolutional codes generate redundant bits continuously, so error checking and correcting are carried out continuously.
2. A Convolutional code is specified by three parameters: n , k , K .
 - A. Input processes k bits at a time.
 - B. Output produces n bits for every k input bits.
 - C. K = constraint length and is a measure of code redundancy.
 - D. k and n generally very small, so they have a lower decoding delay.
3. n -bit output of (n, k, K) code depends on:
 - A. Current block of k input bits.
 - B. Previous $K-1$ blocks of k input bits.
4. Convolutional codes are typically decoded using the **Viterbi algorithm**, which increases in complexity exponentially with the constraint length: K . The Viterbi decoder is a Maximum Likelihood Sequence Estimator, that estimates the encoder state using the sequence of transmitted codewords.

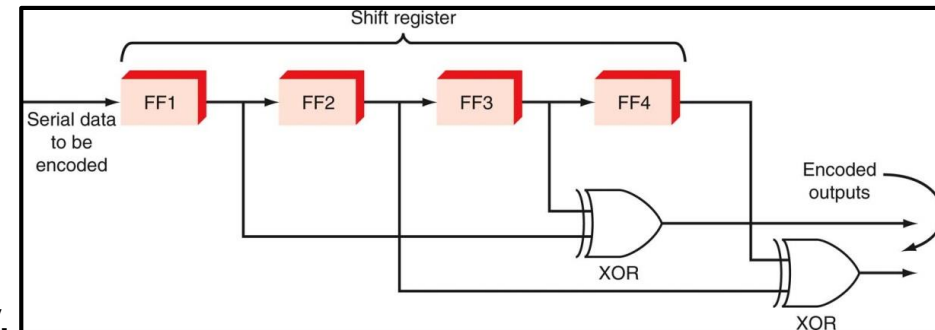

Convolutional Error Correction Codes

Principle of Operation

1. Convolutional encoding creates additional bits from the data, as do Hamming and Reed Solomon codes, but the encoded output is a function of not only the current data bits but also *previously occurring* data bits.
2. Convolutional codes pass the data to be transmitted through a special shift register. As the serial data is shifted through the shift register flip-flops, some of the flip-flop outputs are XORed together to form two outputs.
3. These two outputs are the convolutional code, and this is what is transmitted.
4. The original data itself is not transmitted.
5. Instead, two separate streams of continuously encoded data are sent.
6. Since each output code is different, the original data can more likely be recovered at the receiver by an inverse process.

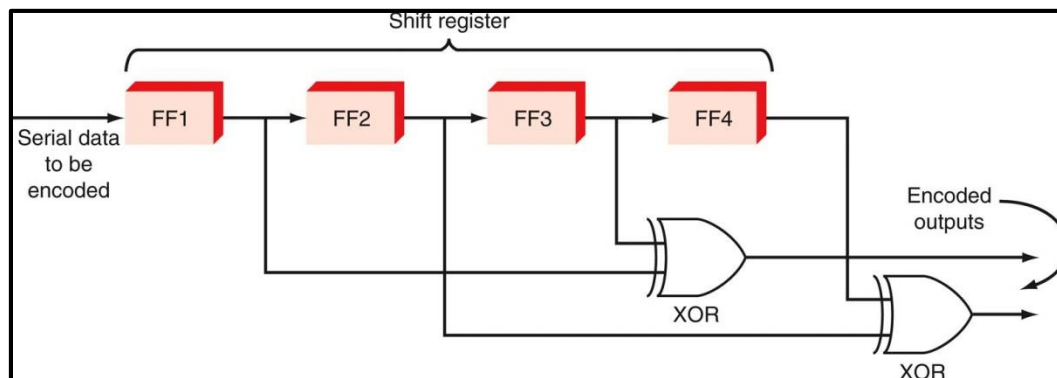

Convolutional encoding uses a shift register with exclusive-OR gates to create the output.

Atlanta RF

Services, Software & Designs

Bite Error Rate for Convolutional Codes

Modulation: Binary Phase Shift Keying (BPSK)

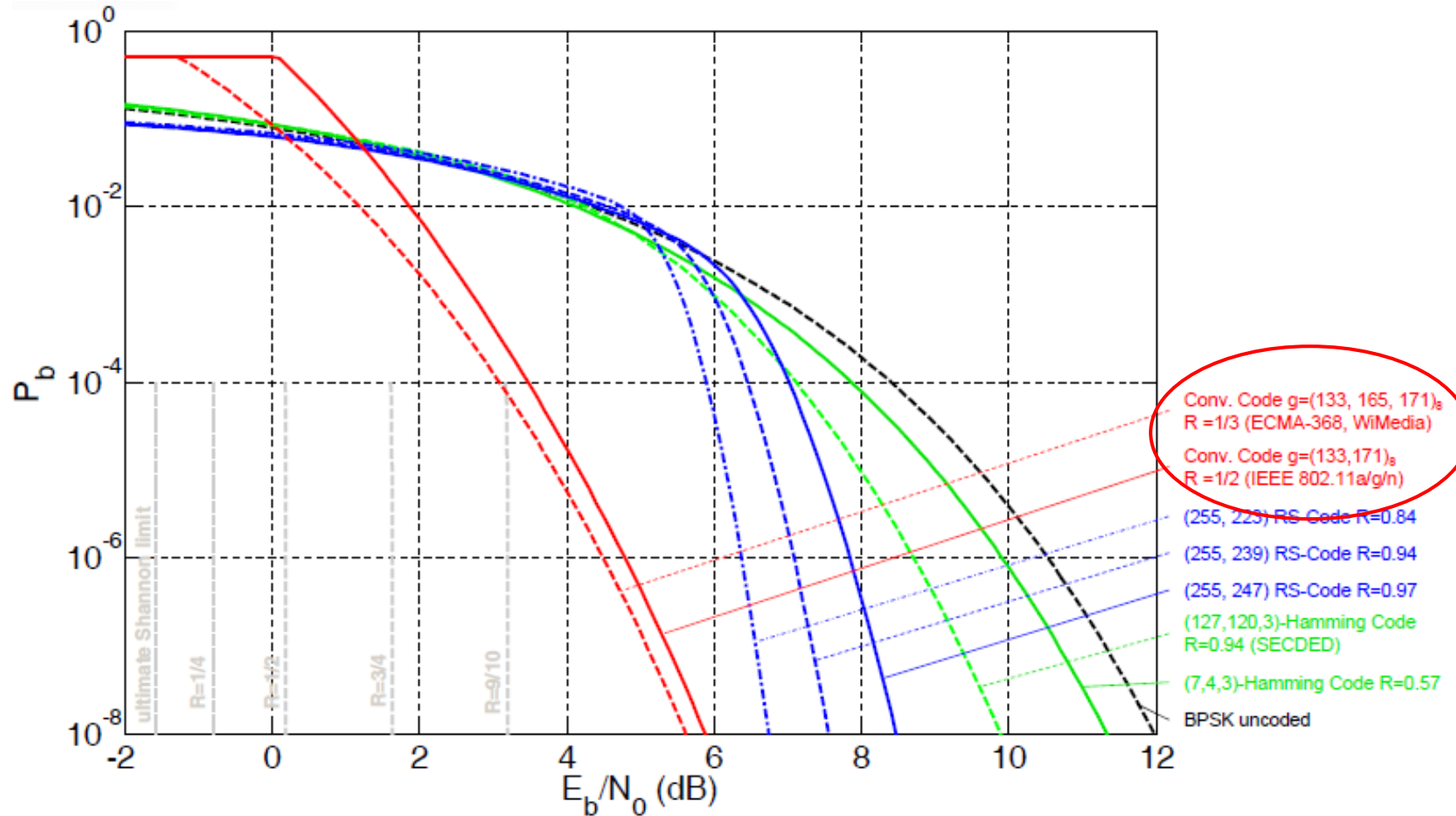

Known Good Convolutional Codes

Generator Polynomials versus $K = \text{Constraint Length}$

Good Codes with Code Rate 1/5

Constraint Length	Generator Polynomials	d_f
3	(5,5,7,7,7)	13
4	(13,15,15,17,17)	16
5	(25,27,33,35,37)	20
6	(57,65,71,73,75)	22
7	(131,135,135,147,175)	25
8	(233,257,271,323,357)	28

Good Codes with Code Rate 1/3

Constraint Length	Generator Polynomials	d_f
3	(5,7,7)	8
4	(13,15,17)	10
5	(25,33,37)	12
6	(47,53,75)	13
7	(133,145,175)	15
8	(225,331,367)	16
9	(557,663,711)	18
10	(1117,1365,1633)	20

Good Codes with Code Rate 1/4

Constraint Length	Generator Polynomials	d_f
3	(5,7,7,7)	10
4	(13,15,15,17)	13
5	(25,27,33,37)	16
6	(53,67,71,75)	18
7	(133,135,147,163)	20
8	(235,275,313,357)	22
9	(463,535,733,745)	24
10	(1117,1365,1633,1653)	27

Good Codes with Code Rate 1/2

Constraint Length	Generator Polynomials	d_f
3	(5,7)	5
4	(15,17)	6
5	(23,35)	7
6	(53,75)	8
7	(133,171)	10
8	(247,371)	10
9	(561,753)	12
10	(1167,1545)	12

LDPC: Low Density Parity Check codes

Link Budget Analysis: *Error Control & Detection*

1. Low Density Parity Check (LDPC) codes were proposed by Robert Gallager* in his 1960 Ph.D dissertation at Massachusetts Institute of Technology, then rediscovered by MacKay and Richardson/Urbanke in 1999.
2. Features of LDPC codes:
 - A. Performance approaching Shannon limit.
 - B. Good block error correcting performance.
 - C. Suitable for parallel implementation.
3. Advantages over Turbo Codes:
 - A. LDPC do not require a long interleaver.
 - B. LDPC's error floor occurs at a lower BER.
 - C. LDPC decoding is not trellis based.

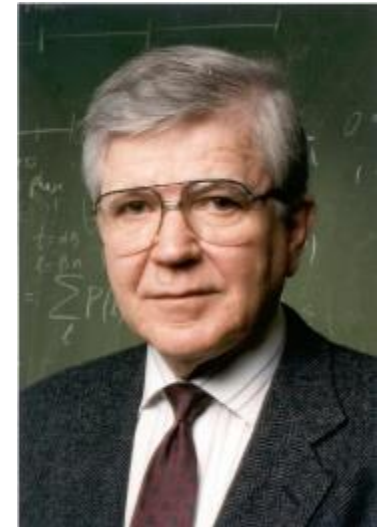

Robert G. Gallager
(1931 -)

* R. G. Gallager, "Low Density Parity Check Codes," Sc.D. thesis, Massachusetts Institute of Technology, Cambridge; September, 1960.

Applications with LDPC Codes

Link Budget Analysis: *Error Control & Detection*

1. Low Density Parity Check (LDPC) codes have superior error performance.
 - A. 4 dB coding gain over convolutional codes (see graph, below).
2. Standards and applications:
 - A. Digital Video Broadcasting: DVB-S2, DVB-T2, DVB-C2.
 - B. Next-Gen Wired Home: Networking (G.hn).
 - C. 10 Gigabit Ethernet (10GBASE-T).
 - D. WiMAX (802.16e).
 - E. WiFi (802.11n).
 - F. Hard disks.
 - G. Deep-space satellite missions.

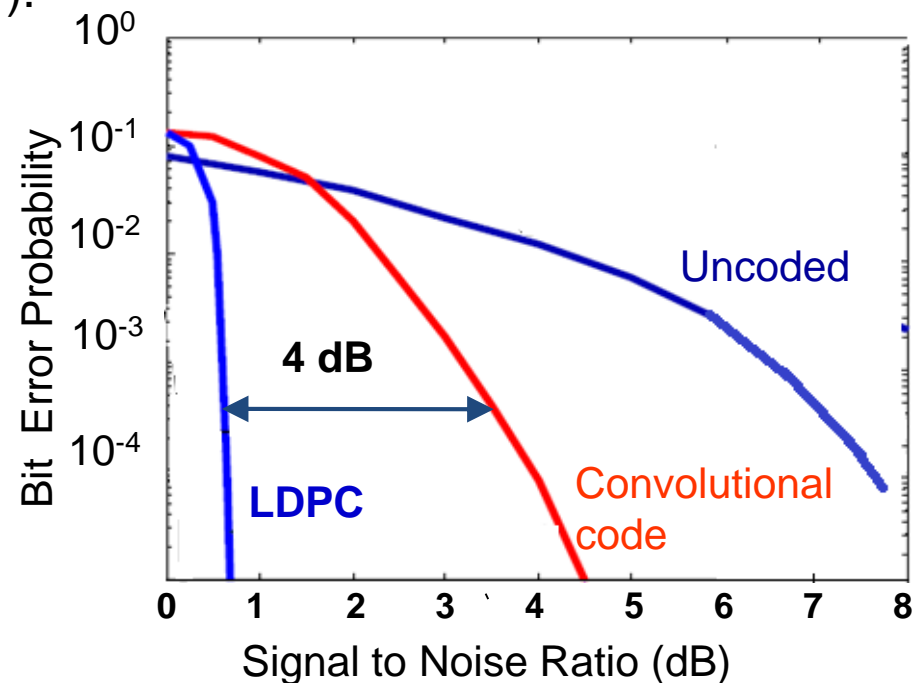

Atlanta RF

Services, Software & Designs

Bite Error Rate for LDPC Codes

Modulation: Binary Phase Shift Keying (BPSK)

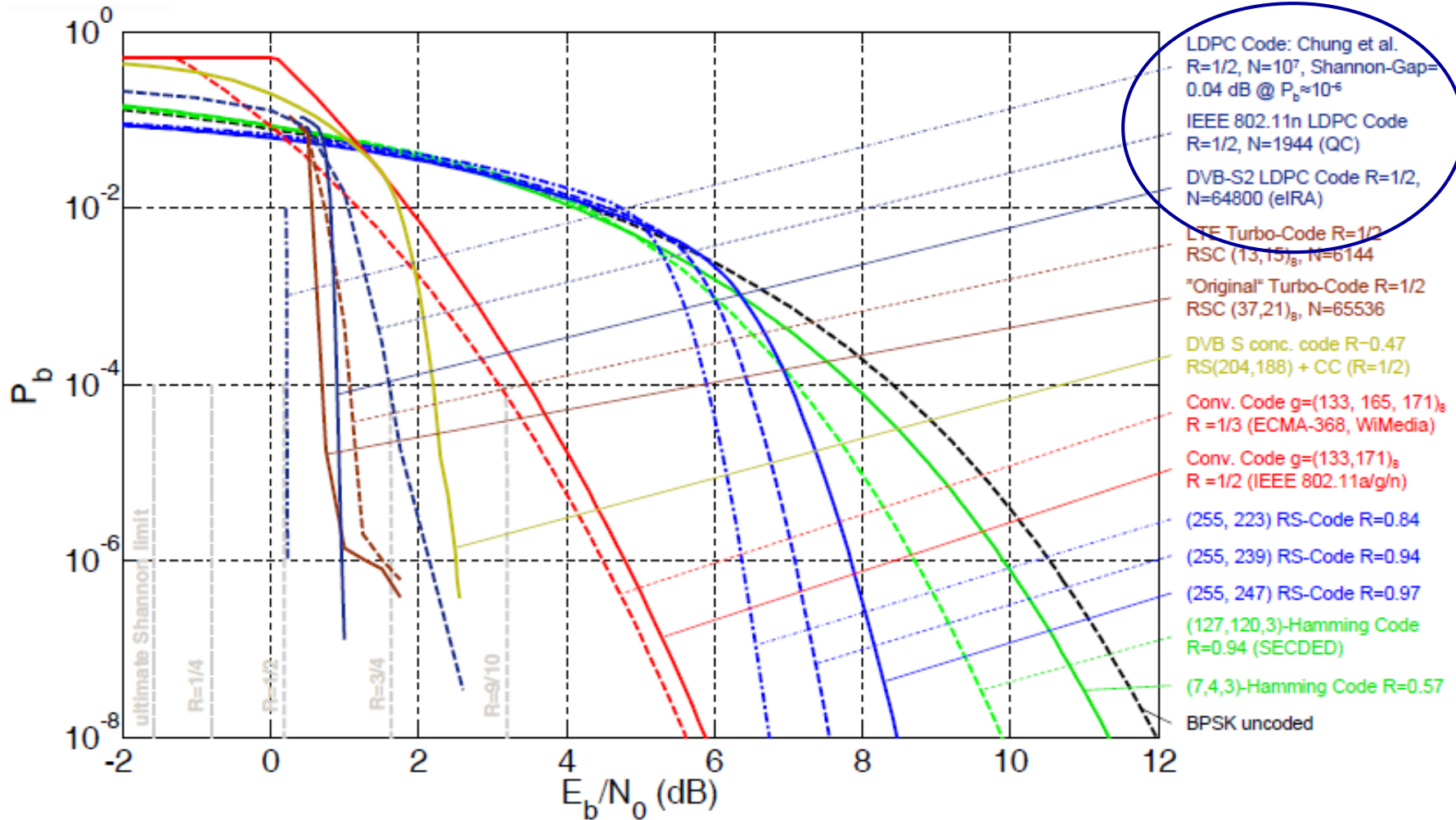

LDPC: Low Density Parity Check.

Atlanta RF

Services, Software & Designs

LDPC: Low Density Error Correction codes

Advantages and Disadvantages

1. **Advantages** of LDPC codes:

- A. Near Capacity Performance.... approaches Shannon's Capacity Limit.
- B. Some LDPC Codes perform better than Turbo Codes.
- C. Trellis diagrams for Long Turbo Codes become very complex and computationally elaborate.
- D. Low BER Floor Error .
- E. Decoding in the Log Domain is quite fast.

2. **Disadvantages** of LDPC Codes:

- A. Can take a long time to converge to a good solution.
- B. Requires very long code word lengths for good decoding efficiency.
- C. Iterative convergence is SLOW.
 - 1) Takes ~ 1000 iterations to converge under standard conditions.
- D. Due to the above reasons, transmission time increases:
 - 1) i.e. Processing: encoding, transmission and decoding
- E. Hence large initial latency/delay:
 - 1) A (4086,4608) LPDC codeword has a latency of almost 2 hours.

Concatenated (Joined) Codes: Overview

Link Budget Analysis: *Error Control & Detection*

A concatenated code uses two separated codes: an **inner code** and an **outer code** (at a higher data rate), which are combined to form a larger code.

1. Popular concatenated codes: Convolutional codes with Viterbi decoding as the inner code and Reed-Solomon codes as the outer code.
2. Example 1: The convolutional code is well-suited for channels with random errors, and the Reed-Solomon code is well suited to correct the bursty output errors common with a Viterbi decoder. An interleaver is used to spread the Viterbi output error bursts across multiple RS codewords.

The purpose is to reduce the overall complexity, yet achieving the required error performance.

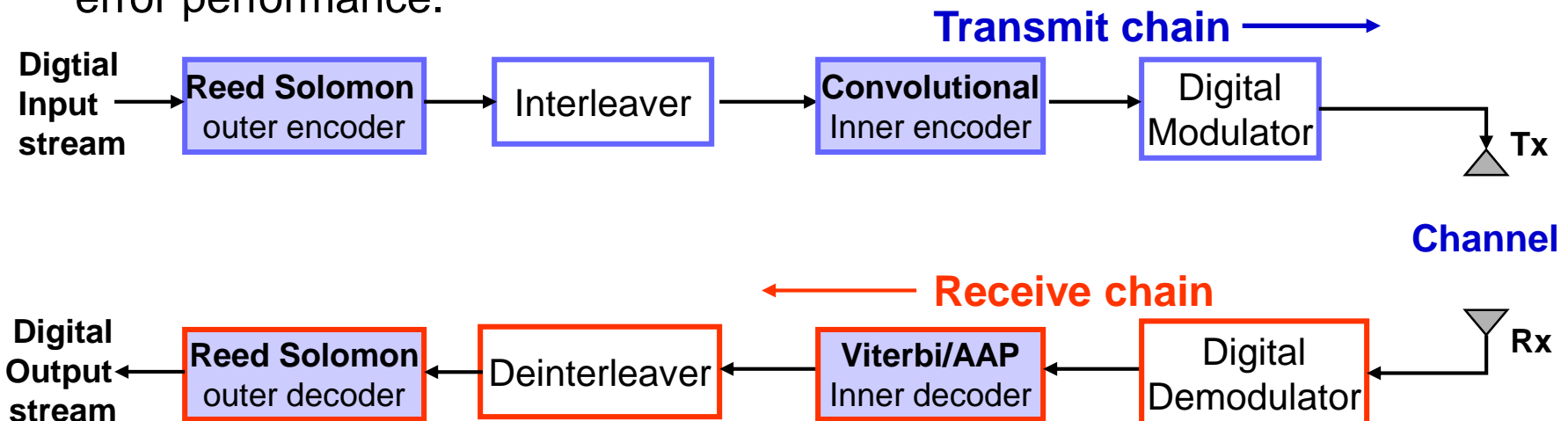

APP: a posteriori probability

Bite Error Rate for Concatenated Codes

Modulation: Binary Phase Shift Keying (BPSK)

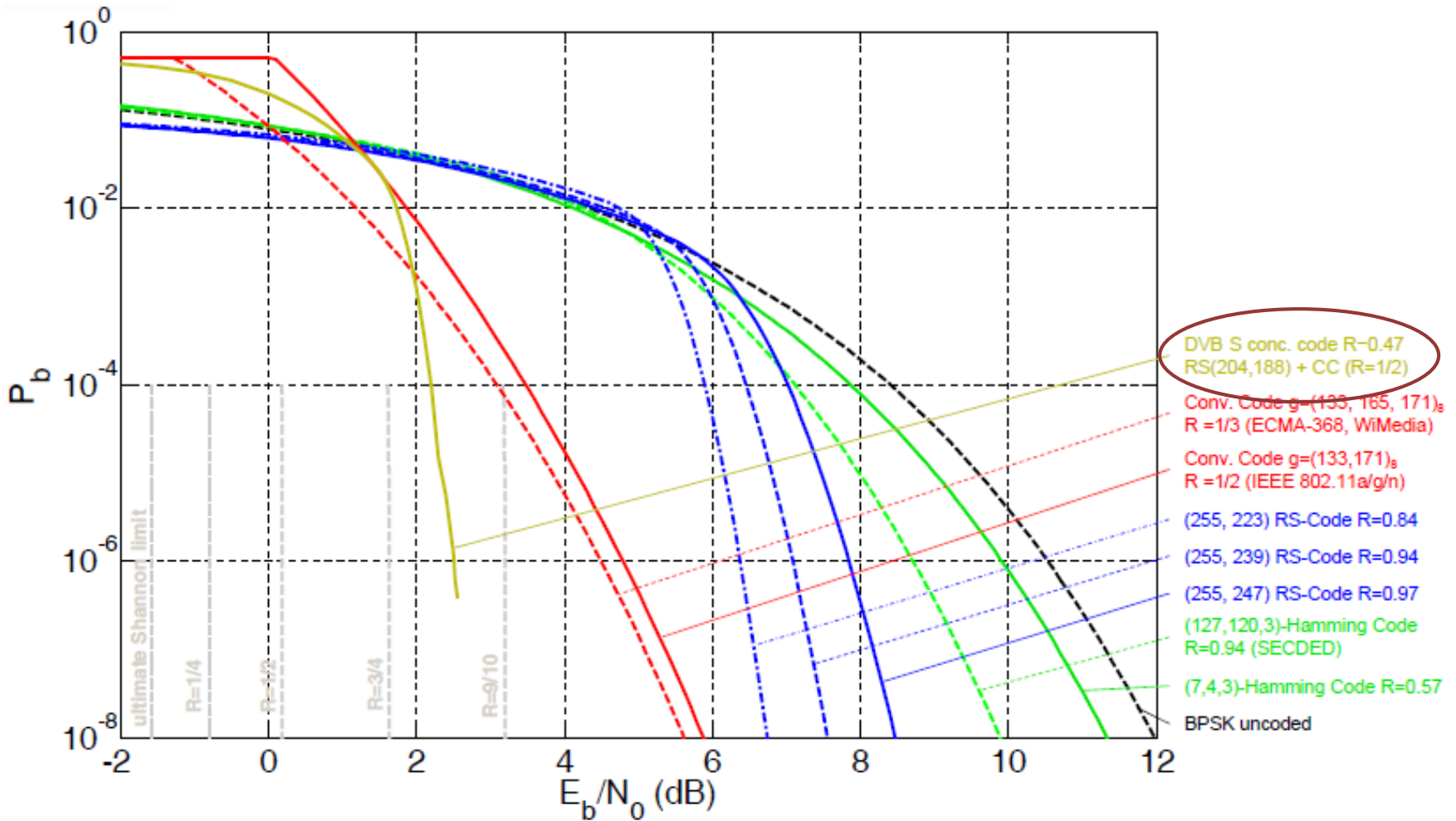

Turbo Error Correcting Codes: Overview

Link Budget Analysis: *Error Control & Detection*

1. Turbo codes were proposed by Berrou and Glavieux* at the 1993 International Conference in Communications . Today, Turbo Codes are considered the most efficient coding schemes for FEC.
2. The name was derived from an ***iterative decoding algorithm*** used to decode these codes where, like a *turbo engine: Part of the output is reintroduced at the input and processed again.*
3. Turbo Codes provided the first known means of achieving decoding performance close to the ***theoretical Shannon capacity***.

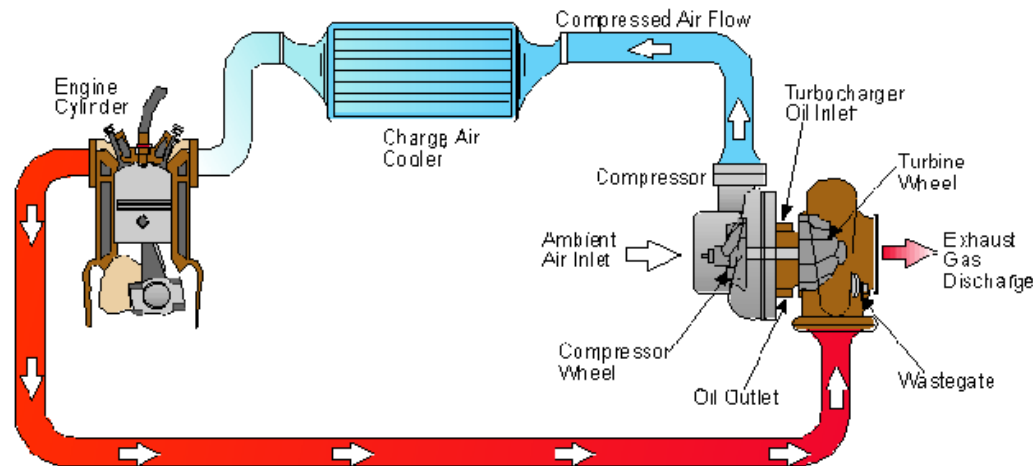

Turbo codes get their name because the decoder uses feedback, like a turbo engine.

* C. Berrou, A. Glavieux, P. Thitimajshima, "Near Shannon Limit Error-Correcting Coding and Decoding: Turbo-Codes", Proc. ICC '93, Geneva, Switzerland, pp. 1064-1070, May 1993.

Turbo Convolutional Codes

Principle of Operation

1. Turbo Codes add error coding diversity by encoding the **same data twice** through concatenation (i.e.: joining 2 convolutional codes).
2. The two decoders, each working on a different **codeword**, can “iterate” and continue to pass reliability update information to each other in order to improve the **probability of converging** on the correct solution. Once some stopping criterion has been met, the final data estimate is provided for use. Essentially concatenating (i.e.: joining) two convolutional codes (may be the same code algorithm):
 - A. One code operates on straight input.
 - B. Other code operates on delayed and interleaved input.
 - C. Decoding involves iteration between the two codes.

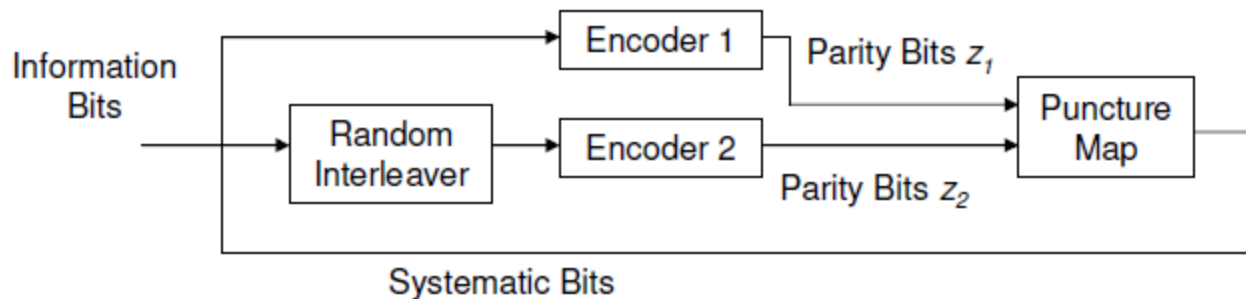

Bite Error Rate for Turbo Codes

Modulation: Binary Phase Shift Keying (BPSK)

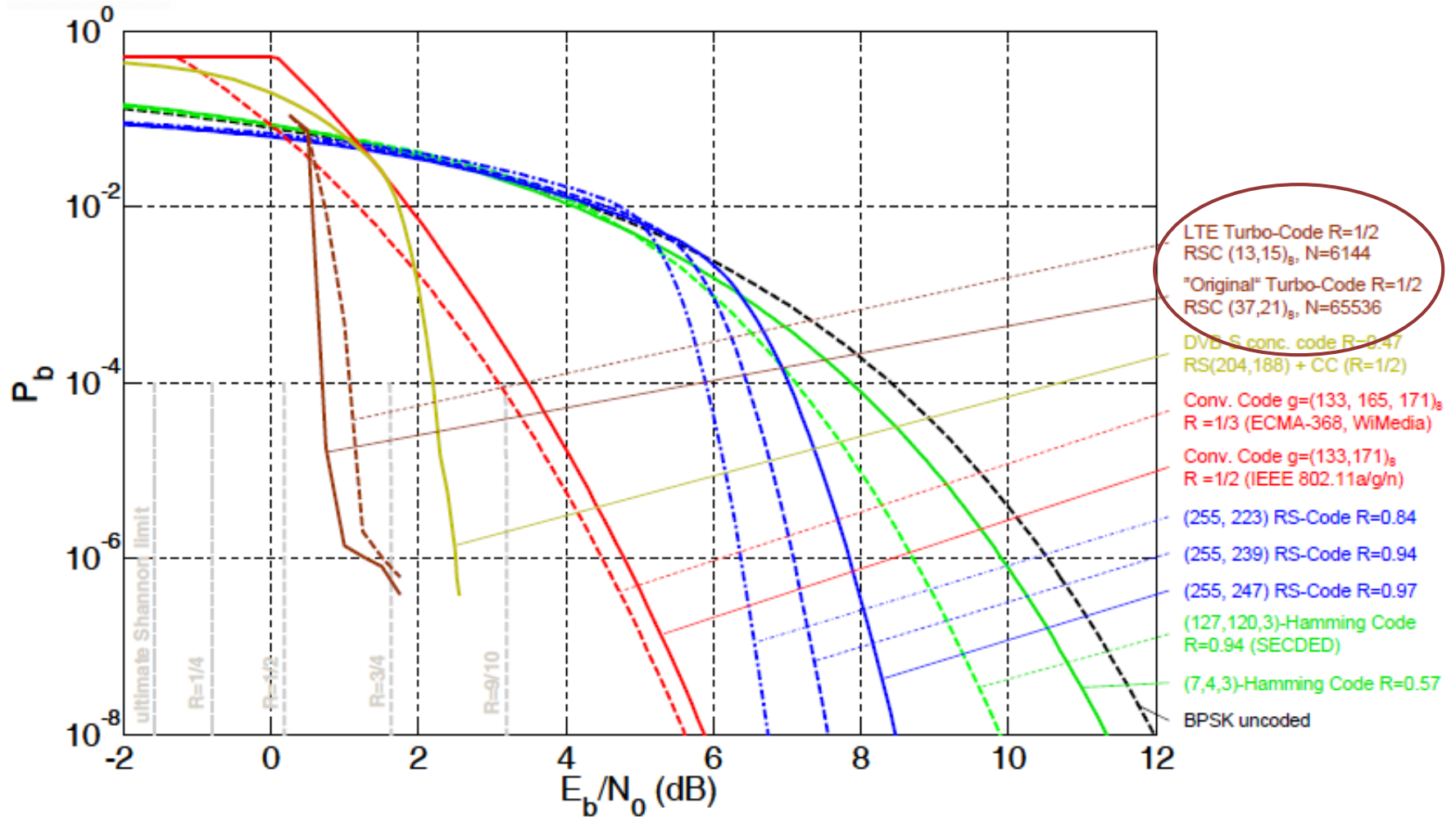

Turbo Code vs Number of Iterations for UMTS

Link Budget Analysis: *Error Control & Detection*

Bit-error performance of the Universal Mobile Telecommunications System (UMTS) turbo code as the number of decoder iterations varies from one to ten. The encoder input word length is $k = 1530$ bits, modulation is BPSK, and channel is AWGN.

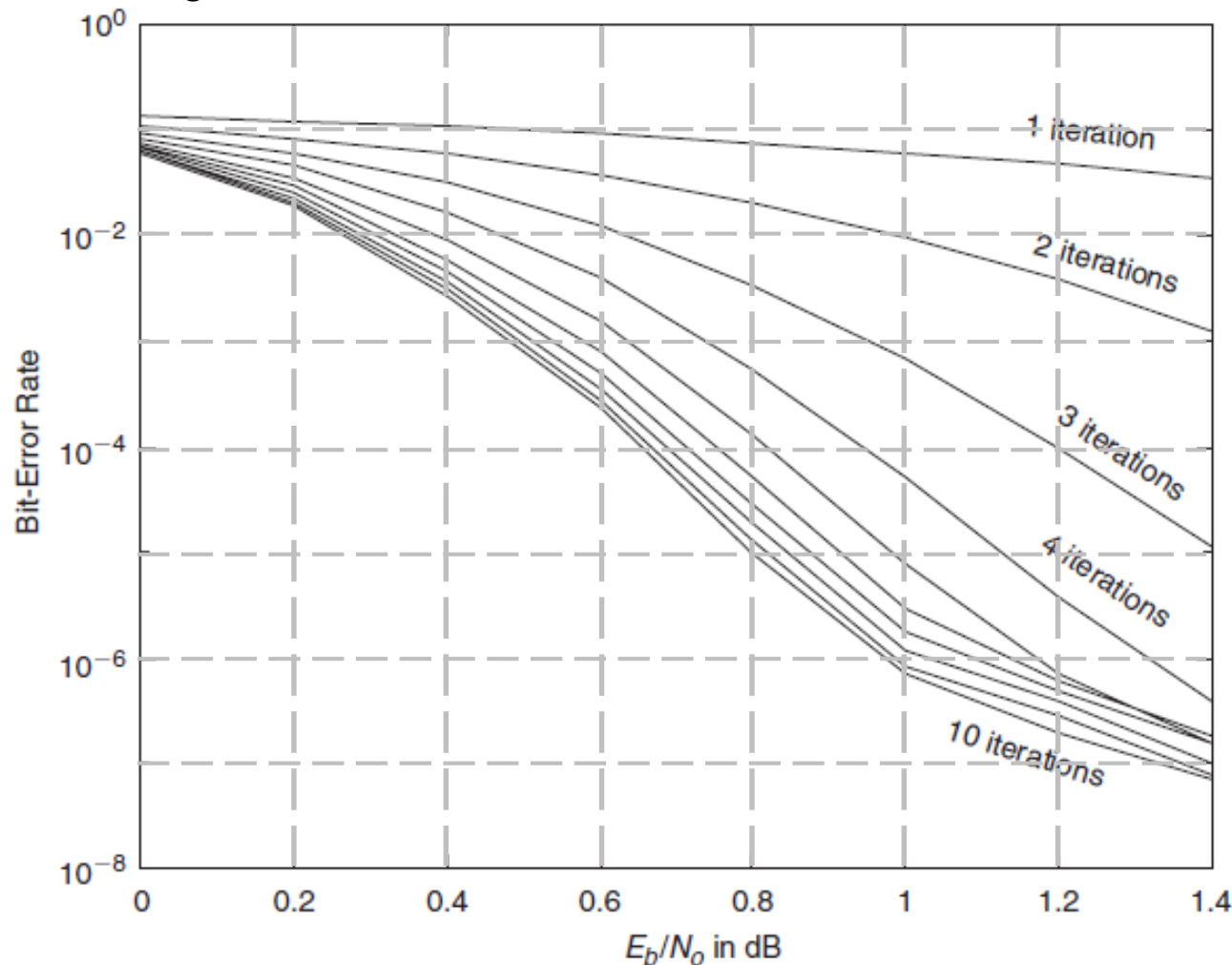

Applications of Turbo Convolutional Codes

Link Budget Analysis: *Error Control & Detection*

Application	Turbo code	Termination	Polynomials	Code Rates
CCSDS (deep space)	Binary, 16-state	Tail bits	23, 33, 25, 37	1/6, 1/4, 1/3, 1/2
UMTS, LTE and CDMA2000 (3GPPx Mobile)	Binary, 8-state	Tail bits	13, 15, 17	1/4, 1/3, 1/2
DVB-RCS (Return Channel over Satellite)	Duo-binary, 8-state	Circular	15, 13	1/3 up to 6/7
DVB-RCT (Return Channel over Terrestrial)	Duo-binary, 8-state	Circular	15, 13	1/2, 3/4
Inmarsat (Aero-H Satellite)	Binary, 16-state	No	23, 35	1/2
Eutelsat (Skyplex Satellite)	Duo-binary, 8-state	Circular	15, 13	4/5, 6/7
IEEE 802.16 (WiMAX)	Duo-binary, 8-state	Circular	15, 13	1/2 up to 7/8

CCSDS: Consultative Committee for Space Data Systems (telemetry standard)

Atlanta RF

Services, Software & Designs

Turbo Code: Advantages & Disadvantages

Link Budget Analysis: *Error Control & Detection*

1. *Advantages:*

- A. Turbo codes have remarkable power efficiency in AWGN and flat-fading channels for moderately low BER.
- B. Design tradeoffs suitable for delivery of multimedia services.

2. *Disadvantages:*

- A. Turbo codes exhibit high latency/delay due to interleaving and iterative decoding.
- B. Poor performance at very low BER.
- C. Because turbo codes operate at very low SNR, channel estimation and tracking is a critical issue.

Turbo Product Codes (TPC)

Link Budget Analysis: *Error Control & Detection*

1. Turbo Product Codes offer excellent performance at high code rates.
2. TPC's have low complexity relative to coding gain.
3. Lower cost and lower power consumption.
4. TPCs offer significant improvement over concatenated Reed-Solomon codes/Viterbi algorithm.
5. A single low cost TPC encoder/decoder can support code rates from 1/5 to 19/20.
6. No puncturing required.
7. Code change 'on the fly' supports changing channel environments.
 - A. Near zero latency, no "tail biting" required.

Turbo Product Code	Block Size	Code Rate
(128,127) x (128,127)	16,383	0.98
(128,120) x (128,127)	16,383	0.93
(64,57) x (32,26)	2,048	0.72
(32,26) x (16,15) x (8,7)	4,096	0.66
(16,11) x (16,11)	256	0.47
(16,11) x (16,11) x (16,11)	4,096	0.32

Turbo Convolutional versus Turbo Product Codes

Link Budget Analysis: *Error Control & Detection*

1. How generated:

- A. Turbo Convolutional Codes (TCC) are generated from Concatenated Convolutional codes.
- B. Turbo Product Codes (TPCs) are based on block codes, not convolutional codes.

2. Code Rate:

- A. TCCs perform best for low code rate applications: Within 1dB of Shannon Limit.
- B. TPCs perform best for high code rate applications.

3. Data Rate:

- A. TCCs will have difficulty achieving high data rates.
- B. TPCs can operate to data rates of 10 Gbps in CMOS.

4. Error Floor:

- A. TCCs exhibit error floor at BERs below 10^{-5} .
- B. TPCs error floor (flare) is less pronounced and at lower BER values.

5. Intellectual Property/Patents:

- A. TCCs require a license from France Telecom.
- B. TPCs based on public domain technology.

Design Trade-offs with Error Correction

Link Budget Analysis: *Error Control & Detection*

1. *Trade-off 1*: Error performance versus Bandwidth

- A. For a fixed Signal-to-Noise value.....
- B. Error correction code produces a smaller BER.
- C. Error correction code → More bandwidth needed to transmit information bits and redundancy bits.

2. *Trade-off 2*: Power versus Bandwidth

- A. For a fixed BER and data rate value.....
- B. Error correction code → smaller E_b/N_0
→ smaller signal: P_r .
- C. Error correction code → More bandwidth needed to transmit information bits and redundancy bits.

3. *Trade-off 3*: Data rate versus Bandwidth

- A. For a fixed BER and Tx power level.....
- B. Error correction code → smaller E_b/N_0
→ bigger data rate: R .
- C. Error correction code → More bandwidth needed to transmit information bits and redundancy bits.

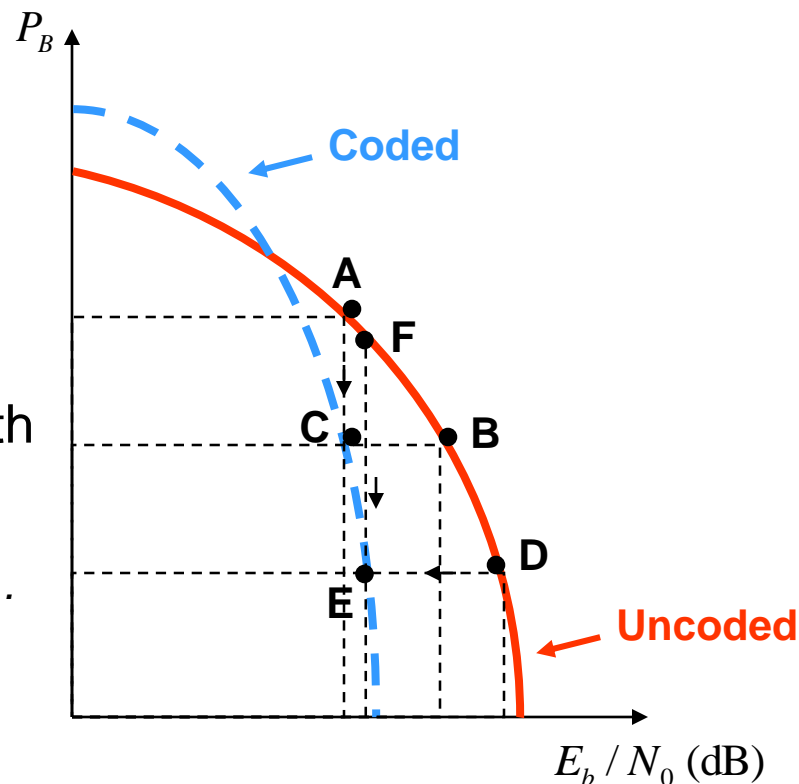

Atlanta RF

Services, Software & Designs



Atlanta RF

Services, Software & Designs

Atlanta RF LLC was founded to provide engineering solutions, design software solutions, and product development solutions to the high-frequency RF/microwave industry in the areas of: Telecommunications (ground segment), Satellite (space segment) and military/defense (RF front-ends).

Through teamwork, Atlanta RF applies our diverse technical experience to your project's challenges with creative and innovative solutions while holding ourselves accountable for the results. With professionalism and commitment to our clients, Atlanta RF will be there for you, both today and tomorrow.

Contact Atlanta RF by e-mail at:

- Atlanta RF **Services** : Services@AtlantaRF.com
- Atlanta RF **Software** : Sales@AtlantaRF.com
- Atlanta RF **Designs** : Designs@AtlantaRF.com

Or, contact Atlanta RF by phone at: 678-445-5544, to reach our Atlanta-area office in Georgia, USA, and discuss our support to your current or future projects & products.

Atlanta RF

Services, Software & Designs

Forward Error Correction & Modulation

Spectral Efficiency vs. Eb/No

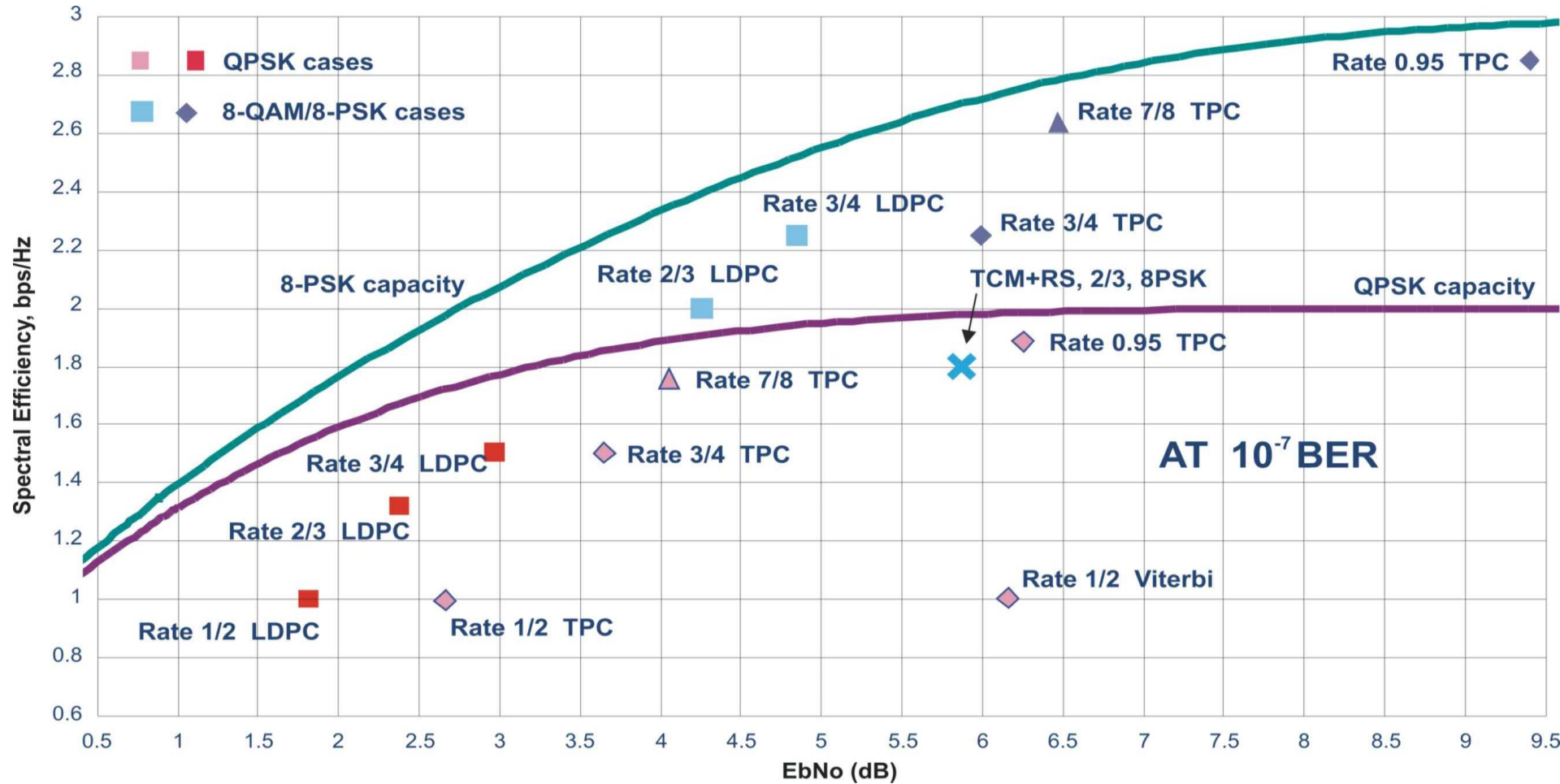

Source: Comtech EF Data: <http://www.comtechefdata.com/technologies/fec>

Presentations by Atlanta RF, LLC

Download various presentations at our website: www.AtlantaRF.com :

1. Satellite: LEO, MEO & GEO.
2. Antennas: An Overview.
3. Link Budget: Getting Started.
4. Link Budget: Digital Modulation Part 1 (Overview & M-ASK).
5. Link Budget: Digital Modulation Part 2 (M-FSK).
6. Link Budget: Digital Modulation Part 3 (M-PSK & QAM).
7. Link Budget: Error Control & Detection.
8. Multiple Access Techniques: FDMA, TDMA and CDMA.
9. Insertion Loss: Double Ridge Waveguide.
10. RF Filters: An Overview.
11. Multi-Section Symmetrical Directional Couplers.
12. Parallel Coupled Bandpass Filters.

Visit our website often as presentations are added for your viewing pleasure.

Atlanta RF

Services, Software & Designs